

UNIGAS 300

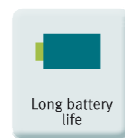
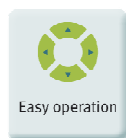
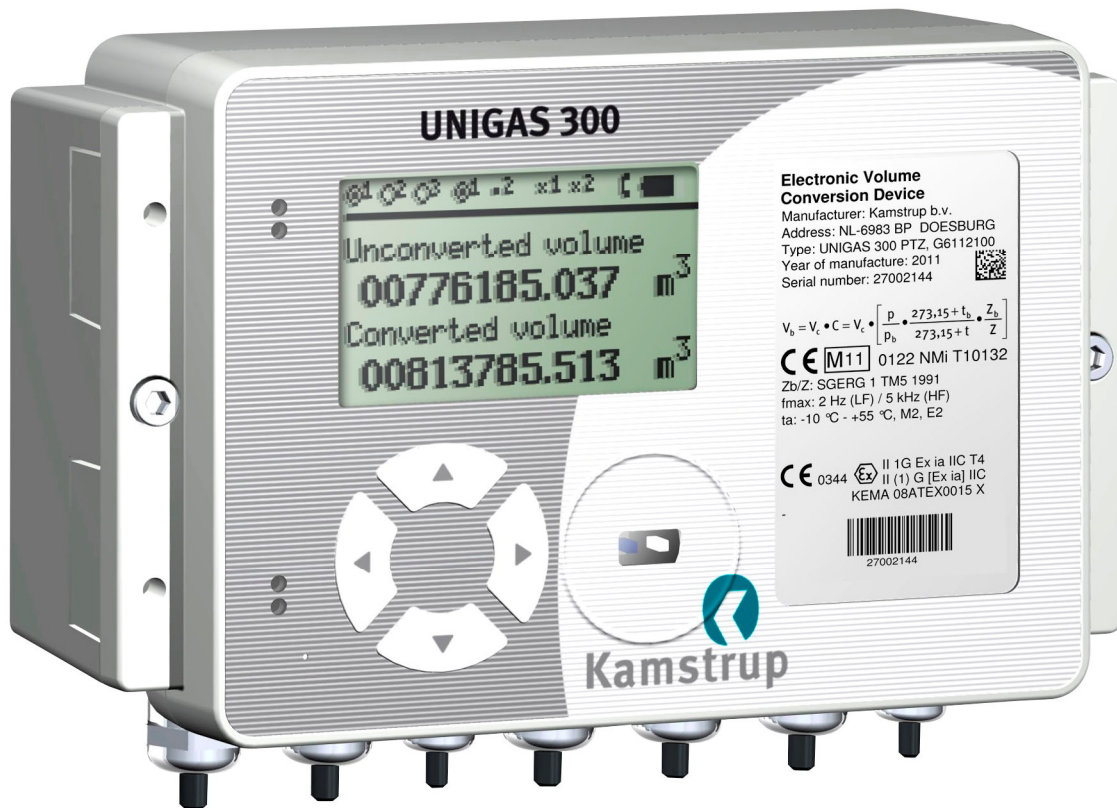

Electronic gas volume converter for all applications

All rights reserved.

Copyright © 2008-2010 Kamstrup b.v., NL-6980 AC Doesburg

All the figures and descriptions in this installation, operating and maintenance manual have been compiled only after careful checking. Despite this, however, the possibility of errors cannot be completely eliminated. Therefore, no guarantee can be given for completeness or for the content. Also, the manual cannot be taken as giving assurance with regard to product characteristics. Furthermore, characteristics are also described that are only available as options.

The right is reserved to make changes in the course of technical development. We would be very grateful for suggestions for improvement and notification of any errors, etc.

With regard to extended product liability the data and material characteristics given should only be taken as guide values and must always be individually checked and corrected where applicable. This particularly applies where safety aspects must be taken into account.

You can obtain further support from the branch or representative responsible for your area. You will find the address on the back of this manual or simply enquire at Kamstrup b.v. Passing this manual to third parties and its duplication, in full or in part, are only allowed with written permission from Kamstrup b.v. The guarantee becomes invalid if the product described here is not handled properly, repaired or modified by unauthorised persons or if replacement parts are used which are not genuine parts from Kamstrup b.v.

Preface

- This manual provides important information about the use of the UNIGAS 300. Please read this manual carefully.
- Various remarks and warnings in this manual are marked with symbols. Read these carefully and take measures where necessary.

The symbols used have the following meaning:



| | | |
|---|----------------|--|
|  | REMARK | Suggestions and recommendations to make tasks easier. |
|  | NOTE | A note draws user's attention to potential problems. |
|  | WARNING | If the procedure is not carried out correctly, a dangerous situation may develop, or data or settings may be lost. |

Table of contents

Preface 2

1 Introduction..... 4

2 Explosion safety instructions (Ex) 6

3 MID and conversion functions 8

3.1 Measurement Instruments Directive (MID)8

3.2 Conversion functions.....9

3.2.1 Gas meter error curve correction11

3.2.2 Handling conversion functions 11

3.2.3 Determining the flow rate and consumption.....11

3.2.4 Loggers and log books 12

3.3 Other functions 14

3.3.1 Impulse outputs 14

3.3.2 Alarm outputs 14

3.3.3 Battery consumption counter..... 14

4 Installation 15

4.1 Main components 15

4.2 Connections..... 17

4.3 Connecting a gas meter with encoder output 18

4.4 Mounting and connecting cables 19

4.5 Temperature sensor 21

4.6 Pressure sensor 21

5 Sealing layout 22

6 Control and display..... 23

7 Maintenance..... 30

7.1 Adjusting 30

7.2 Replacing the pressure sensor or the temperature sensor..... 30

8 Replacing the battery 33

9 Sensor pockets for temperature sensor 35

10 Counters and registers 36

11 Technical specifications 46

12 EC Declaration of conformity ATEX 54

13 EC Type Examination Certificate 55

14 EC Declaration of conformity MID 58

15 MID EC Type Examination Certificate 59

16 Correction of gas meter measuring error..... 60

17 Determination of volume difference when two impulse inputs are used 61

1 Introduction

UNIGAS 300 consists of a processor unit and a temperature sensor, whereas the PT and PTZ versions also contain a pressure sensor. It is used in combination with a gas meter for conversion of the measured gas volume.

The gas volume is converted to reference conditions t_b and p_b according to the formula below:

$$V_b = V_c \cdot \frac{p}{p_b} \cdot \frac{273,15 + t_b}{273,15 + t} \cdot \frac{Z_b}{Z}$$

Where p is expressed in bar absolute and t in °C, and where Z is calculated on the basis of the algorithm stored in the instrument.

The electronic system is divided over two PCB's placed in an aluminium housing.

The bottom of the housing contains a PCB responsible for measurement, conversion and power supply. The cover contains a PCB responsible for control and read-out through the display or serial communication.

UNIGAS 300 has three optical serial ports.

Other available functions are:

- three programmable LF impulse inputs for gas meters with LF impulse outputs
- Namur input for gas meters with HF impulse output or encoder output
- two alarm inputs for normally close contacts
- two programmable real-time impulse outputs
- two alarm outputs
- programming using software UNITOOL and infrared (IR) communication head or remote through a modem connection
- serial communication with two permanent infrared connectors, one for connecting a modem and the other for communication with a process computer
- advanced programmable logger functions
- module space for future applications
- real-time clock

UNIGAS 300 comes in three versions, that is with:

- external temperature sensor
- external temperature sensor and internal pressure sensor
- external temperature sensor and external pressure sensor

With regard to conversion, UNIGAS 300 is available in four versions:

- PTZ (conversion on the basis of pressure, temperature and compressibility)
- TZ (conversion on the basis of temperature and compressibility)
- PT (conversion on the basis of pressure and temperature)
- T (conversion on the basis of temperature)

UNIGAS 300 can issue several alarm and warning signals. The level on which an alarm or warning is issued can be set. The alarms and warnings can be set for the pressure measured, the temperature measured and all flow registers.

UNIGAS 300 is provided with an ingenious circuit to ensure that battery life is not affected when the impulse outputs are used.

The scope of delivery at least includes:

- electronic volume conversion device UNIGAS 300
- this manual
- test report
- configuration report

Accessories (optional):

- Lithium-Thionyl chloride D-cell G8610070000
- Lithium-Thionyl chloride DD-cell G8610080000
- Test valve type BDA 04 for connecting pressure calibration equipment O31200
- Software UNITool G6900000
- Universal fastening set including mounting material GG6391
- Flange mounting bracket GG6338
- Infrared communication head U16699099
- Flexible stainless steel connecting hose for pressure connection, 0,5 m GG8710
- Flexible stainless steel connecting hose for pressure connection, 0,7 m GG8713
- Flexible stainless steel connecting hose for pressure connection, 1 m GG8711
- Module for activation of communication port for process computer GG6605
- Communication-interface module GG6604

2 Explosion safety instructions (Ex)

UNIGAS 300 is approved for use in potentially explosive atmospheres according to group II, category 1 where an explosive atmosphere is likely to occur through the presence of mixtures of air and gas, while the explosive atmosphere is present continuously or for long periods or frequently.

UNIGAS 300 is also approved for use in non-explosive atmospheres where the inputs of UNIGAS 300 may be connected with sensors placed in the potentially explosive atmosphere and where the outputs of UNIGAS 300 may be connected with other equipment in the non-explosive atmosphere without the use of intrinsically safe barriers.

The type of protection complies with the requirements of intrinsic safety.

The approval data are:



The ambient temperature T_a is defined as:

$$T_a = -40 \text{ to } +55 \text{ } ^\circ\text{C}$$



These instructions for use must be read and understood completely before UNIGAS 300 is installed and taken into operation. If there should be any questions or ambiguities with regard to explosion safety in connection with UNIGAS 300, then please contact Kamstrup (see the information at the back of this manual).



Special approval data (also see chapters 11 and 13):

1. Since the UNIGAS 300 housing is made of aluminium, when used in a potentially explosive atmosphere to which the use of equipment of category 1 G applies, installation must take place in such a manner that, even in the event of extraordinary incidents, it is prevented that ignition sources can develop that result from impact or friction with the housing
2. When using UNIGAS 300 in a potentially explosive atmosphere to which the use of equipment according to category 1 G applies, measures must be taken to prevent ignition due to electrostatic charges.
3. For the version with external pressure sensor, with a view to explosion safety, it must be taken into account that the pressure sensor circuit is connected to earth.



Additional instructions with regard to explosion safety:

1. Always prevent moisture from entering the housing when it has been opened.
2. On closing the housing, carefully check that the cover seal fits closely with the housing over the full edge. Also check that the two screws in the cover are placed and tightened.
3. When installed in a potentially explosive atmosphere, all connections with cables that carry signals to a space outside the potentially explosive atmosphere, must be fitted with intrinsically safe barriers that are carefully chosen and installed.
4. Only genuine batteries of type G8610070000 or G8610080000 supplied by Kamstrup can be used to replace the battery. Replacing can take place in a potentially explosive atmosphere. See chapter 8 for additional information.
5. All cables connected to the UNIGAS 300 must be stripped as short as possible and fixed thoroughly using cable glands. Unused cable glands must be sealed using the supplied blank plugs that must be fixed thoroughly.
6. Cables must only be fed through cable glands intended for that purpose, see figure 1.
7. The transparent synthetic covers of the inputs and outputs must be in place, see figure 1.
8. The shield of the shielded cable must securely be connected to the cable gland. See chapter 4, *Installation*, and chapter 7.2, *Replacing the pressure sensor or the temperature sensor*.
9. When replacing a pressure sensor or a temperature sensor, all electrical cables connected with the appliance as well as the battery must be uncoupled.

10. If an external power supply is connected, it must be Ex certified and be in accordance with the Ex specifications of the connections. See chapter 11, *Technical specifications*.
11. External power supply and battery power can be used simultaneously.
12. If UNIGAS 300 is installed in a potentially explosive atmosphere, the front of the housing must be cleaned by only using a damp cloth to prevent generation of static electricity.
13. In the event of a malfunction, UNIGAS 300 must be repaired by Kamstrup.

See chapters 11 and 13 for the Ex specifications of the connections.

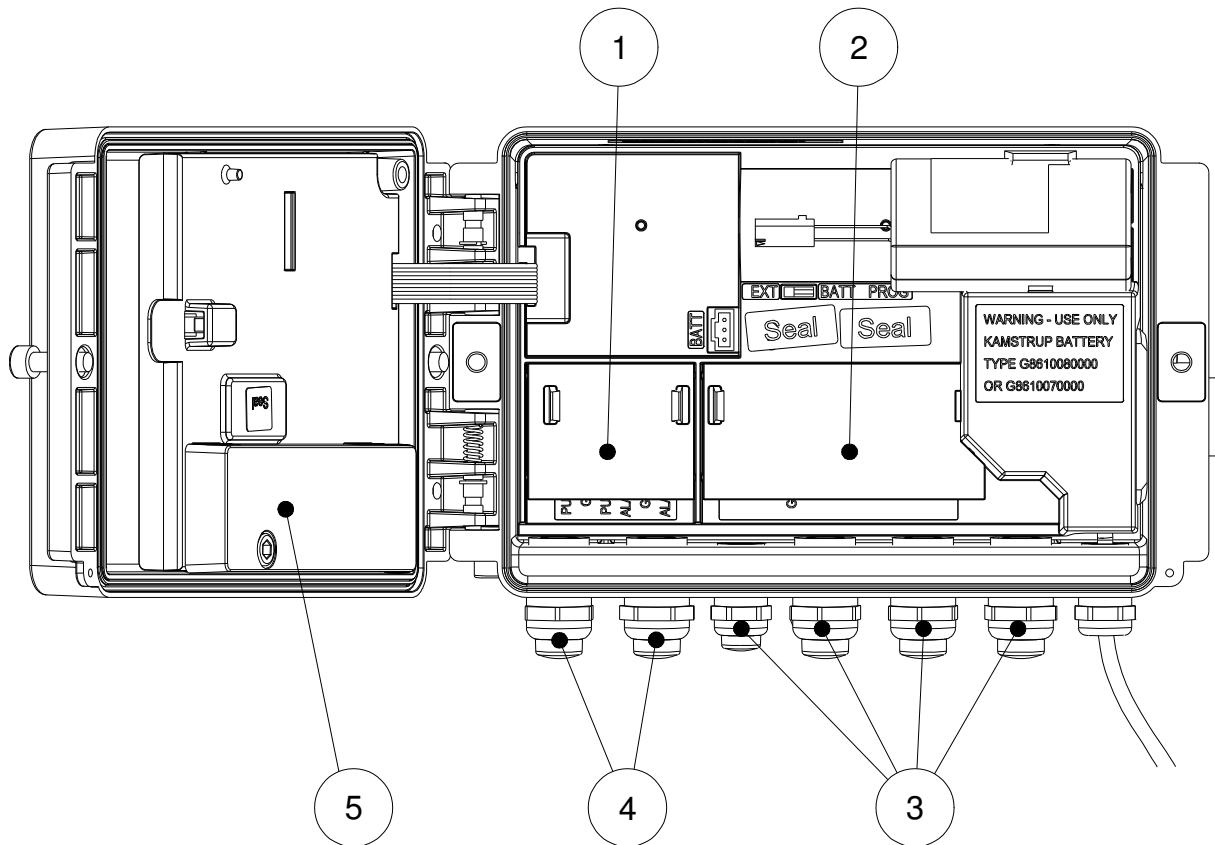

Figure 1. Covers and cable glands for inputs and outputs

- 1: Cover outputs
- 2: Cover inputs
- 3: Cable glands for inputs
- 4: Cable glands for outputs
- 5: Cover of module space

3 MID and conversion functions

3.1 Measurement Instruments Directive (MID)

UNIGAS 300 is MID-approved and complies with standard EN12405-1/A1.

Calibration-relevant data are stated on the main label at the front of the UNIGAS 300 housing.

The main label contains the following data:

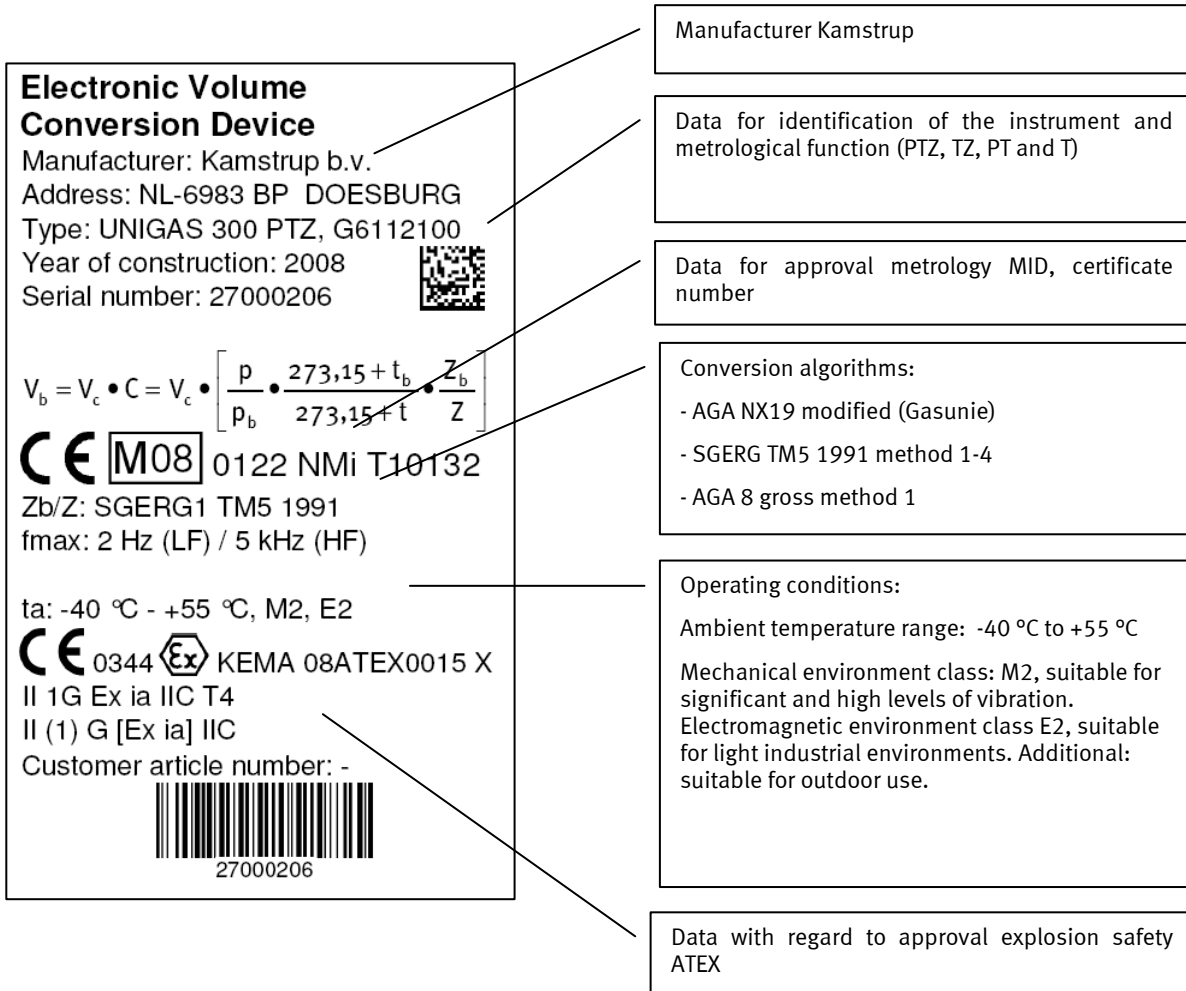

Figure 2. Main label

The values of impulse ratios, gas composition, gas temperature range and pressure ranges, serial numbers pressure sensor and temperature sensor, reference pressure and reference temperature can be shown on the display. See menu items: ► 9; System, ► 7; Inputs and outputs and ► 2; Parameters.

Also see chapter 6; *Human interface and control*.

Maintenance and repair:

It is permitted for the UNIGAS 300 owner to install or replace modules and to replace the battery.

After every repair, UNIGAS 300 must be verified again in an accredited laboratory.

3.2 Conversion functions

UNIGAS 300 has three inputs of which input 1 can be configured for connecting a gas meter with an LF impulse output, an HF impulse output or an encoder output.

Inputs 2 and 3 are only suitable for connection of a gas meter with an LF impulse output.

Several counters are connected to the three inputs. Counters for correcting the gas meter measuring error and counters for conversion are connected to input 1.

Figure 3 shows the interrelations between conversion and other functions. Chapter 10 contains a further explanation of all counters and registers present in UNIGAS 300.

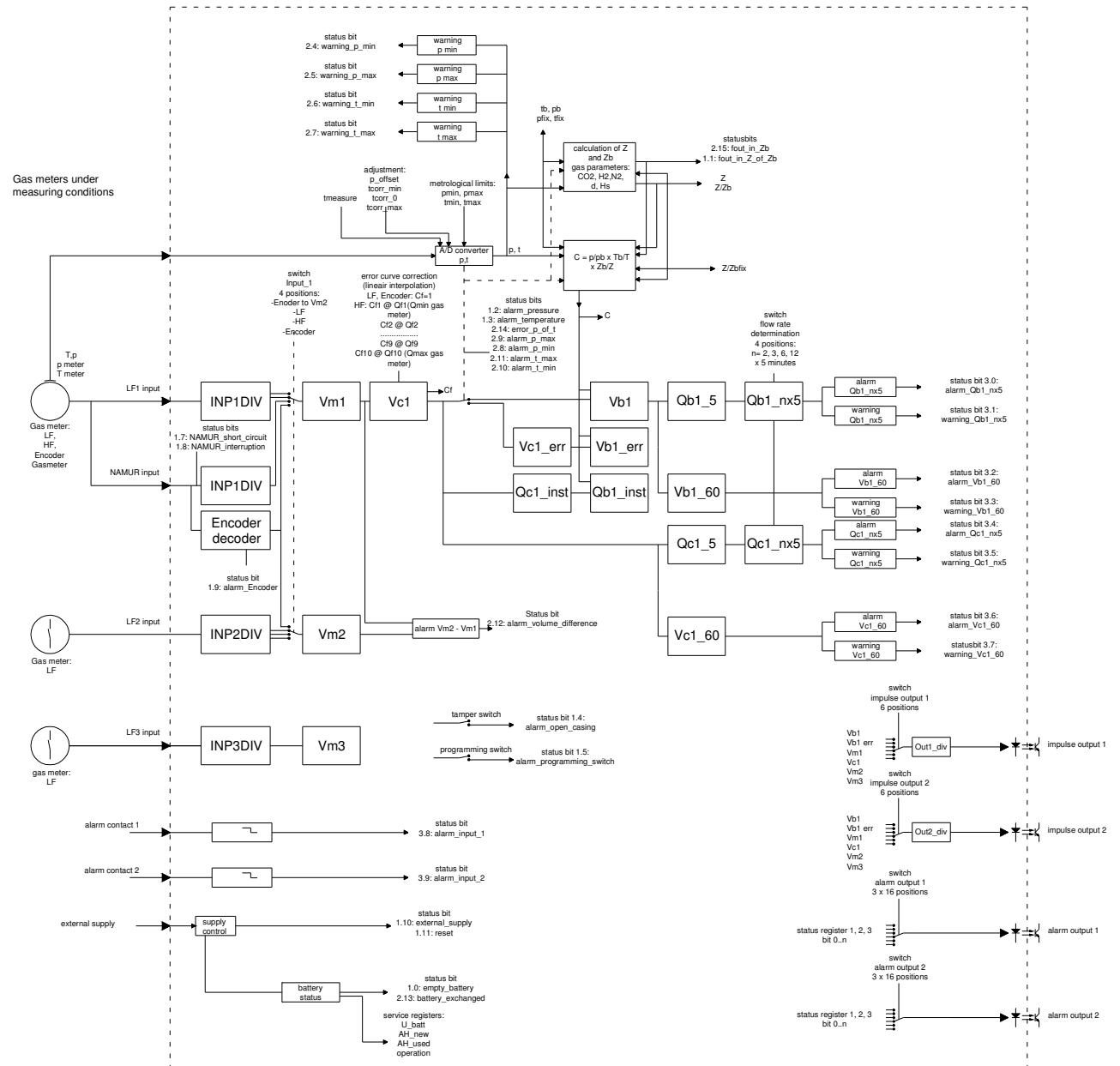

Figure 3. Functions in block diagram

When using a gas meter with two LF impulse outputs, receipt of the impulses of one of the impulse outputs can be checked. For that purpose the counter readings of input 2 are compared with those of input 1. Also see chapter 17.

When using a gas meter with both an LF impulse output and an encoder output, receipt of the LF impulses can be checked with the aid of the encoder. For that purpose the LF impulse output of the gas meter is connected to input 1 of UNIGAS 300, whereas input 2 is configured for connecting the encoder output of the gas meter. In this application the encoder counter is only read out once every 5-min interval in order to reduce the energy consumption and to extend battery life.

Dependent on the version, T, TZ, PT and PTZ (see main label), the conversion is carried out as follows:

T: conversion with $C = \text{pfix}/\text{pb} \times (\text{tb} + 273,15) / (\text{t} + 273,15) \times \text{Zbfix}/Z$

TZ: conversion with $C = \text{pfix}/\text{pb} \times (\text{tb} + 273,15) / (\text{t} + 273,15) \times \text{Zb}/Z$

PT: conversion with $C = \text{p}/\text{pb} \times (\text{tb} + 273,15) / (\text{t} + 273,15) \times \text{Zbfix}/Z$

PTZ: conversion with $C = \text{p}/\text{pb} \times (\text{tb} + 273,15) / (\text{t} + 273,15) \times \text{Zbfix}/Z$

where pfix, tfix and Zbfix are fixed, preset values.

If an error condition occurs for pressure or temperature, or in determining the compressibility, or in the event of a CRC error in the firmware for the conversion functions, conversion will be continued as described below, with replacement values pfix, tfix or Z/Zbfix being used for pressure, temperature, Z or Zb.

The error condition is indicated by a blinking exclamation mark (!) in the display (display in main screen 1, see chapter 6).

In the error condition:

- counting continues in Vm1 and Vc1
- conversion in Vb is stopped
- the relevant status bit is set (see chapter 6):
 - o pressure measurement fails or is outside range of pmin to pmax: *alarm pressure* and *error p* or *t*
 - o temperature measurement fails or is outside range of tmin to tmax: *alarm t* and *error p* or *t*
 - o determination of Z fails: *error Z* or *Zb*
 - o Zb determination fails: *error Z or Zb* and *error Zb*
 - o CRC error in software responsible for conversion: *CRC error conversion*
- counting will continue in Vc1_err
- conversion takes place in Vb1_err with relevant replacement values
 - o pressure measurement fails or is outside range of pmin to pmax: t and pfix
 - o temperature measurement fails or is outside range of tmin to tmax: p and tfix
 - o determination of Z fails: p, t and Z/Zbfix
 - o Zb determination fails: p, t and Z/Zbfix
 - o CRC error in software responsible for conversion: p, t and Z/Zb
- the display shows the values of pfix, tfix or Z/Zbfix for p, t and Z/Zb.

The responses to an error condition as described above, apply to an instrument with conversion on the basis of PTZ. For the other versions, T, TZ, PT, conversion for p, t or Z and Zb takes place with tfix, pfix and Zbfix, so the response to failure of p, t, Z or Zb does not apply.

The compressibility Z and Zb are calculated according to an algorithm. The following algorithms are available for UNIGAS 300:

- AGA NX19 modified (Gasunie)
- SGERG TM5 1991 method 1-4
- AGA 8 gross method 1

The algorithm stored in UNIGAS 300 (see main label), is a complete algorithm. This means that interpolation or tables are not applied. Consequently, the accuracy of the calculation of Z or Zb will match the accuracy of the algorithm itself.

Specific gas compositions are known for which - at certain temperatures - the compressibility cannot be calculated correctly by the algorithm. UNIGAS 300 itself will detect such a case and handle it as a failing Z or Zb calculation and continue the conversion as described above.

The following calibration characteristics can be modified using the UNITOOL software.

| | | |
|----------------------------|------------------|--|
| Input 1 | 0.1 – 100,000 | impulses/m ³ |
| Input 2 | 0.1 – 100 | impulses/m ³ |
| Input 3 | 0.1 – 100 | impulses/m ³ |
| CO ₂ | 0 – 30.00 | mol % |
| H ₂ | 0 – 10.00 | mol % |
| N ₂ | 0 – 50.00 | mol % |
| d | 0.5000 – 0.9000 | - (at 0 °C) |
| H _s | 14.00 – 48.00 | MJ/m ³ (at 25°C) |
| Z/Z _{bfix} | 0.5000 – 1.5000 | - |
| Measuring interval p and t | 5-25 | s (set as standard at 25 s) |
| t _b | 0-25.00 | °C (set as standard at 0 °C) |
| p _b | 800.00 – 1200.00 | mbar (set as standard at 1013.25 mbar) |

UNIGAS 300 will not accept a value outside the defined range.

Writing is protected by a calibration switch which is to be actuated during programming. Changes are stored in the calibration log book, see 3.2.4.

3.2.1 Gas meter error curve correction

UNIGAS 300 features a function for error correction of a gas meter. This correction is possible if the high-frequency impulse input on UNIGAS 300 is used. The error correction complies with standard EN12405-1.

The corrected volume is counted in counter Vc1. This will be discussed further in chapter 16.

If a low-frequency impulse or encoder input is used, the function of error correction of the gas meter is switched off, counter Vc1 is equal to Vm1 and Vc1 cannot be set.

3.2.2 Handling conversion functions

Pressure, temperature and compressibility are measured and calculated every measuring interval. The conversion depends on the signal input used:

- LF: real-time conversion at descending flank of the gas meter impulse
- HF: every second at presence of gas meter impulse(s)
- encoder: every measuring interval directly following the measurement of pressure and temperature and determination of compressibility.

3.2.3 Determining the flow rate and consumption

UNIGAS 300 determines the flow rate for input 1

- Instantaneous flow rate:
 - LF: based on the interval between the two most recent impulses (Qb1_inst and Qc1_inst)
 - HF: based on the received number of impulses per second (Qb1_inst and Qc1_inst)
 - encoder: based on the measuring interval (Qb1_inst and Qc1_inst)
- Consumption on the basis of an interval:
 - the measured volume for 5 min (Qb1_5 and Qc1_5)
 - a moving average of a series of 5-min values (Qb1_nx5 and Qc1_nx5)
 - consumption in a clock hour (Vb_60 and Vc_60).

3.2.4 Loggers and log books

UNIGAS 300 is equipped with ample memory for data storage. UNIGAS 300 contains the following loggers and log books. A list of loggers follows below.

- 1 **Interval logger (load-profile):** logging takes place every 5 min. The logged data can be displayed as 5, 10, 15, 30 or 60-min values. The characteristics of interval logger are:

- 150 days (43,200 items), ring memory
- readable on display (menu item 4, see chapter 6) and through serial communication

Stored items include:

- date/time
- Vb1
- Vb1_err
- Vm1
- Vc1
- Vm2
- Vm3
- t
- p
- status registers 1, 2 and 3

- 2 **Day logger:** logging takes place every day (24 h). This moment can be set and as standard it is set at 6:00 hours (end of a gas day).

Characteristics:

- 100 days, ring memory
- readable on display (menu item 5, see chapter 6) and through serial communication

Stored items include:

- date/time
- Vb1
- Vb1_err
- Vm1
- Vc1
- Vm2
- Vm3
- t
- p
- status registers 1, 2 and 3

- 3 **Month logger:** every month UNIGAS 300 logs current values. This logging takes place on the last day of the month at a preset time (as standard: 6:00 hours).

Characteristics:

- 60 items (5 years), ring memory
- readable on display (menu item 6, see chapter 6) and through serial communication

Stored items include:

- date/time
- Vb1
- Vb1_err
- Vm1
- Vc1
- Vm2
- Vm3
- t
- p
- status registers 1, 2 and 3

The following applies to all loggers:

- Each storage is provided with a CRC. If, when reading takes place, the CRC does not equal the calculated CRC, the data are not shown.
- All counter readings are stored with a resolution of 1 m³.

Two log books are present in UNIGAS 300.

- 1 **Status log book:** each status message is logged with a date/time stamp.

Characteristics:

- 360 items, ring memory
- readable through serial communication

Stored items include:

- date/time
- bit number and status register number, including the information regarding the nature of the status message (event or start and end of a condition)

- 2 **Calibration log book:** every change of the value of calibration-relevant parameters is logged with a date/time stamp.

Characteristics:

- 360 items, ring memory
- readable through serial communication

Stored items include:

- date/time
- OBIS code modified parameter
- old value modified parameter
- new value modified parameter
- Vc1 at the moment of programming
- Vb1 at the moment of programming
- value of status register 1
- value of status register 2
- value of status register 3

3.3 Other functions

3.3.1 Impulse outputs

The two impulse outputs can be coupled to one of the six counters. The scaling factor can freely be configured for each impulse output between 1 and 100 m³/impulse.



Impulse issue takes place real-time at a maximum frequency of 2 Hz. The scaling factor must be set in regards to this maximum frequency to prevent that impulses are temporarily buffered by UNIGAS 300 at p_{max} and Q_{max} .

3.3.2 Alarm outputs

The two alarm outputs can be coupled to a status bit from one of the three status registers. At the moment when the status bit is created, an impulse of 0.1 s is issued. As long as the status bit is active, a 0.1-s impulse is issued every 5-min interval.

3.3.3 Battery consumption counter

UNIGAS 300 is provided with a battery consumption counter. This device calculates the battery capacity used on the basis of the time passed and the total of the consumption of the functions performed (pressure and temperature measurement, communication and encoder or HF input).

The battery consumption counter will stop as soon as an external supply is connected. If this external supply should fail, the battery consumption counter will resume recording.

When the battery is replaced by means of menu item 10, the battery consumption counter will be reset.

4 Installation

The UNIGAS 300 housing is IP66 (jet-proof) in accordance with EN 60529 and can be installed outdoors. See chapter 2; *Explosion safety instructions (Ex)*.

Mounting

A mounting plate is available for UNIGAS 300 that can be used to mount UNIGAS 300 on a wall, in a cupboard or on a gas meter. A universal flange mounting bracket is also available that can be used in combination with the above mounting plate to mount UNIGAS 300 on a gas meter flange.

4.1 Main components

Front

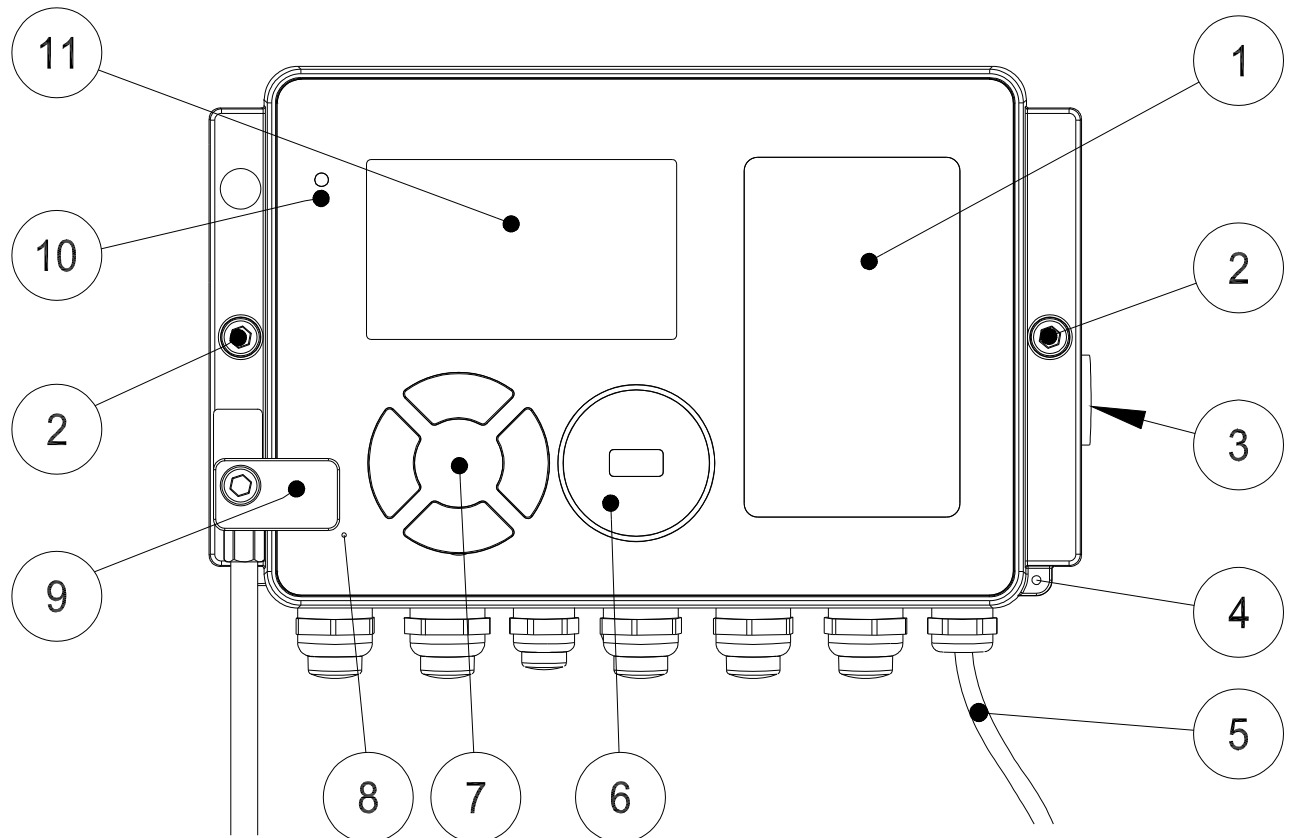

Figure 4. Front view UNIGAS 300

- 1: Main label, see chapter 3.
- 2: Housing lock. Unscrew these two bolts until the bolt heads are roughly level with the UNIGAS 300 front. Then open the housing on the right-hand side. The seal may stick, so it may take some effort to open the housing.
- 3: Pressure sensor and connection. For UNIGAS 300 supplied with an external pressure sensor, a cable gland is here. The external pressure sensor comes with a cable of approx. 3 m. It is not permitted to cut this cable. Any excess cable must be tied up.
- 4: Security seal. The housing can be sealed by affixing a security wire seal.
- 5: Cable for temperature sensor. The temperature sensor comes with a cable of approx. 3 m. It is not permitted to cut this cable. Any excess cable must be tied up.
- 6: Communication port for reading out and configuring UNIGAS 300 on site. This communication port is suitable for use of an infrared communication head with the UNITOOL software.



The infrared communication head used for the Kamstrup heat, cold, water and electricity meters and UNIGAS PT(Z) 61E is not suitable for UNIGAS 300.

- 7: Keypad for controlling UNIGAS 300.
- 8: Breather opening for pressure equalisation between UNIGAS 300 and ambient atmosphere. Behind the breather opening a membrane is placed that prevents ingress of moisture.



Take care not to damage the membrane.

- 9: Communication port 1 for remote communication, including connection of a modem using an infrared connector. This infrared connector is shown in the figure.
- 10: Communication port 2 for communication with, e.g., a process computer. Through this communication port the gas consumer can read out data on consumption etc. This communication port is specifically intended for local and frequent data readout. Reading out frequently does not affect the performance of UNIGAS 300. It does reduce the service life of the battery. To activate the port a module must be placed. Application notes are available for connecting the port to an RS232, USB or TTL serial port. Contact Kamstrup for more information.
- 11: Dot matrix display. The display is activated when one of the navigation keys is operated. If the navigation keys are not operated for 1 min, the display will be switched off.

Inside

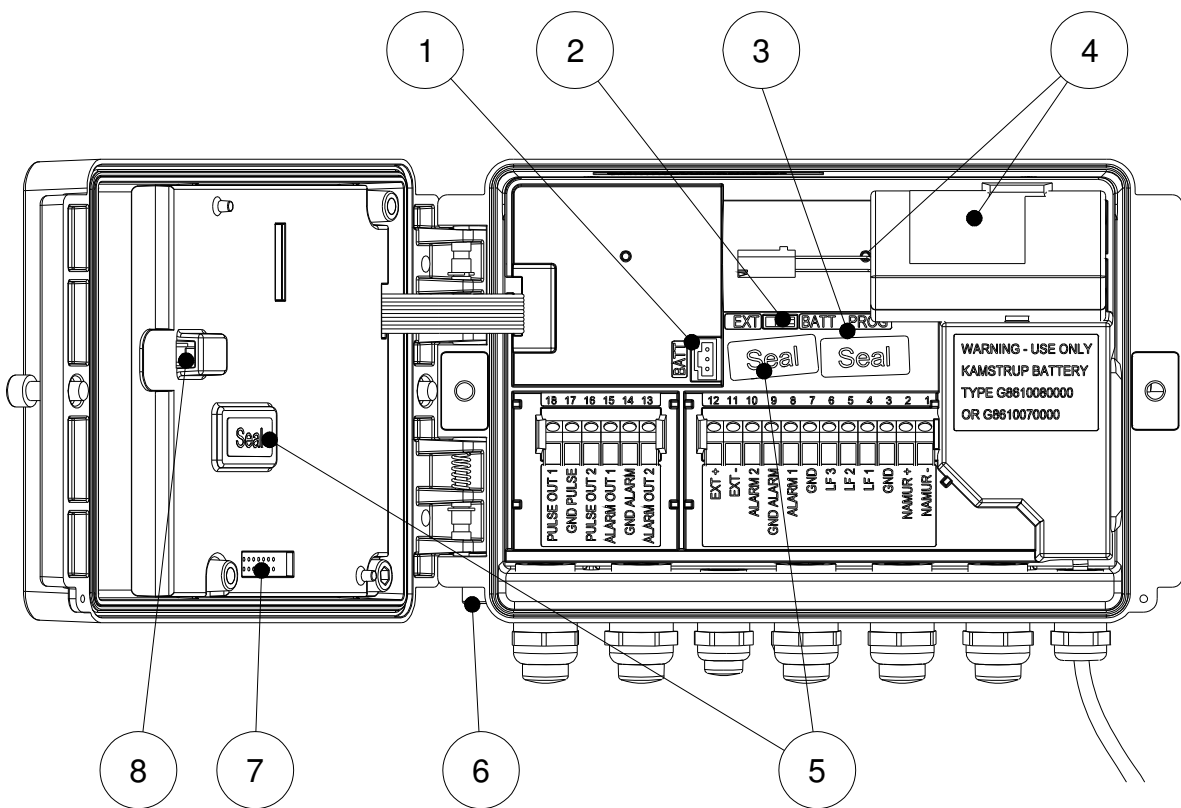

Figure 5. Interior view UNIGAS 300

- 1: Connection for battery.
- 2: Jumper for battery power or external power. When external power is used, this jumper must be placed in the position EXT; when battery power is used this jumper must be in the position BATT. If this jumper is in the position EXT while no external power is available, the system will automatically switch to battery power.



When external power is used and the jumper is in the position BATT, UNIGAS 300 will shut down.

When the HF impulse input is used, external power is necessary.

- 3: Calibration lock / calibration switch. The calibration switch must be actuated while programming a calibration parameter. This calibration switch can be operated with a pin (e.g. with the tip of ballpoint). The calibration switch is to be sealed with an adhesive seal.
- 4: Battery holder. When using a DD cell, the break-off tab that fixes the D cell must be cut.
- 5: Fixation of the PCB and the protective cover. The bolt is sealed with a sticker seal.

- 6: Connection for earthing.
- 7: Module connector with protective cap (PCB cover not shown in figure 5). Nothing but Kamstrup modules can be connected to his module connector. This module connector is retroaction-free, which means that manipulation of the module connector will not affect the calibration functions.
- 8: Tamper switch. UNIGAS 300 detects the opening of the housing and records this event in status register 1.

4.2 Connections

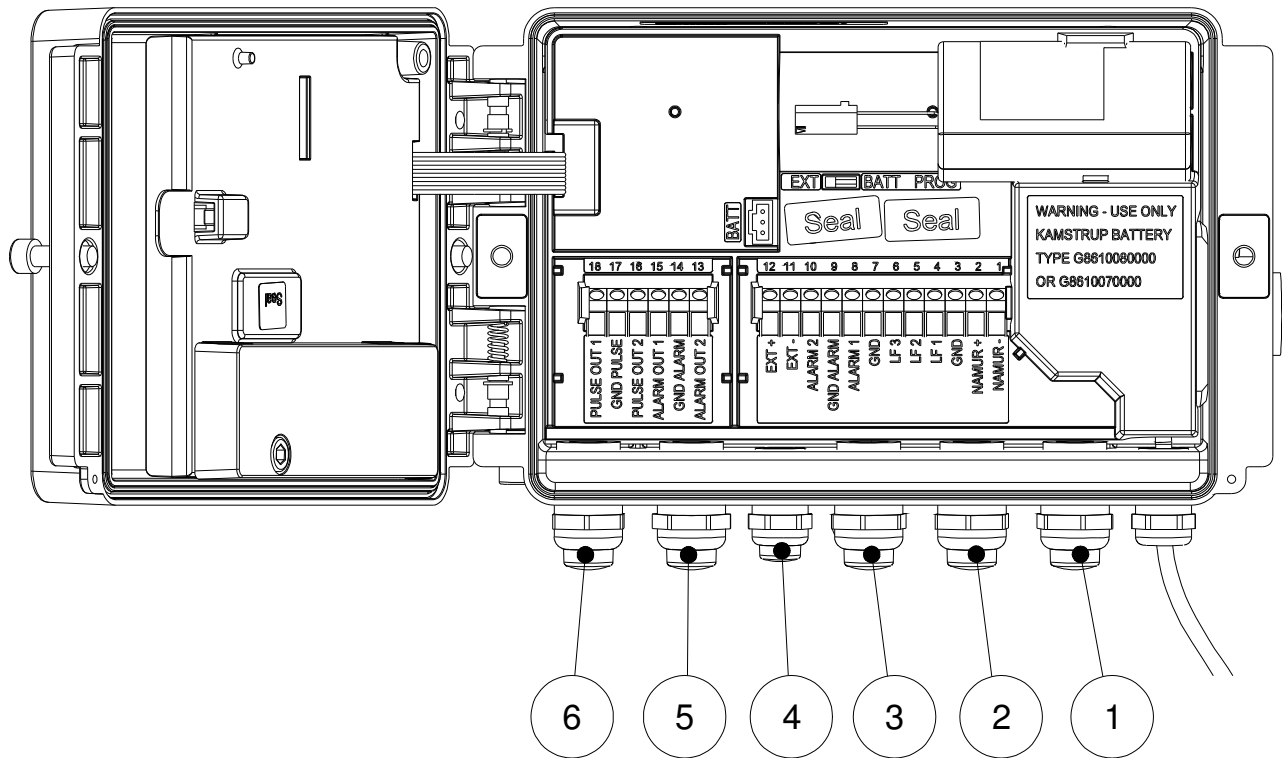

Figure 6. Connections

- 1: Cable gland for input 1 (LF / HF / encoder)
- 2: Cable gland for input 2 (LF) and input 3 (LF)
- 3: Cable gland for alarm inputs 1 and 2
- 4: Cable gland for external power supply
- 5: Cable gland for alarm outputs 1 and 2
- 6: Cable gland for impulse outputs 1 and 2



Unused cable glands must be sealed with the supplied sealing caps.

The inputs are numbered successively from 1 to 12 and the outputs are numbered from 13 to 18. The numbers and references are stated at the terminals.

Inputs

| | | |
|----|-----------|---|
| 1 | NAMUR - | connection for NAMUR sensor and encoder counter |
| 2 | NAMUR + | connection for NAMUR sensor and encoder counter |
| 3 | GND | - common earth for LF sensor |
| 4 | LF 1 | + connection for LF input 1 |
| 5 | LF 2 | + connection for LF input 2 |
| 6 | LF 3 | + connection for LF input 3 |
| 7 | GND | - common earth for LF sensor |
| 8 | ALARM 1 | alarm input 1, normally closed switch or transistor |
| 9 | GND ALARM | common earth for ALARM 1 and 2 |
| 10 | ALARM 2 | alarm input 2, normally closed switch or transistor |
| 11 | EXT - | - connection for external power supply 5 – 10 V |
| 12 | EXT + | + connection for external power supply 5 – 10 V |

Outputs

| | | |
|----|-------------|------------------------------------|
| 13 | ALARM OUT 2 | alarm output 2 |
| 14 | GND ALARM | common earth for ALARM OUT 1 and 2 |
| 15 | ALARM OUT 1 | alarm output 1 |
| 16 | PULSE OUT 2 | impulse output 2 |
| 17 | GND PULSE | common earth for PULSE OUT 1 and 2 |
| 18 | PULSE OUT 1 | impulse output 1 |

For electrical data of the pulse and alarm outputs, see chapter 11.

4.3 Connecting a gas meter with encoder output

Gas meters with encoder output with NAMUR interface of make GWF or Elster can be used. The UNITool software can be used to set input 1 for encoder input.



Before the encoder is connected, counter Vm1 (or Vm2 in the event the encoder input is used for checking impulse input 1) must be configured at a value that matches the value on the encoder counter.

If the above action is not performed, UNIGAS 300 will start converting the difference between the encoder counter and the UNIGAS 300 counter at the first measuring interval.

If an encoder is connected while the counter reading is lower than the counter value in UNIGAS 300, UNIGAS 300 will not take over the encoder counter reading. A status message of that event will be set in status register 1.

If the encoder counter decreases, the counter reading will not be taken over by UNIGAS 300. A status message of that event will be set in status register 1. If the decrease is temporary, UNIGAS 300 will take over it as soon as it has become larger than the last counter reading that had been taken over. The decrease is not recorded in any error counter.

4.4 Mounting and connecting cables

UNIGAS 300 comes with cable glands fitted with EMC shielding. The cables must be mounted correctly. Mounting instructions are given below step-by-step.

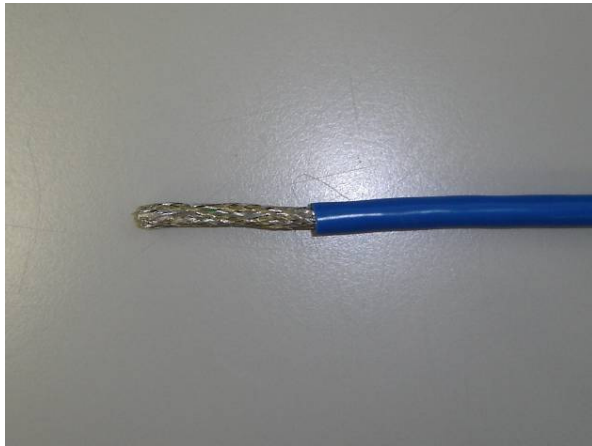

1: Remove the sheath over 35 mm

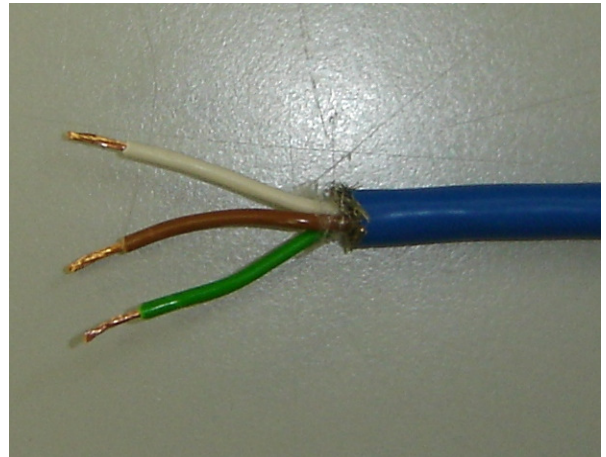

2: Remove shield. Strip the cores over 7 mm

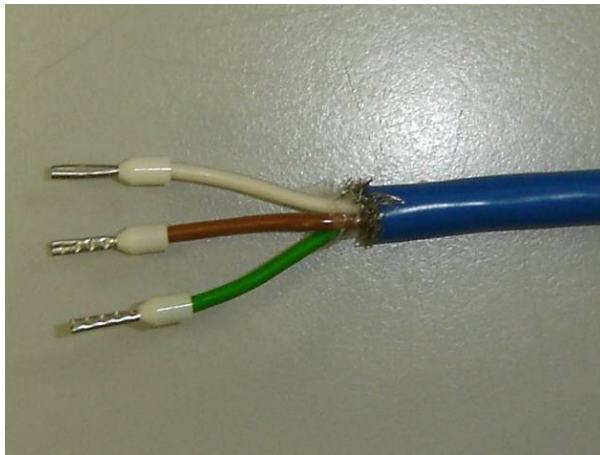

3: Place cable crimps

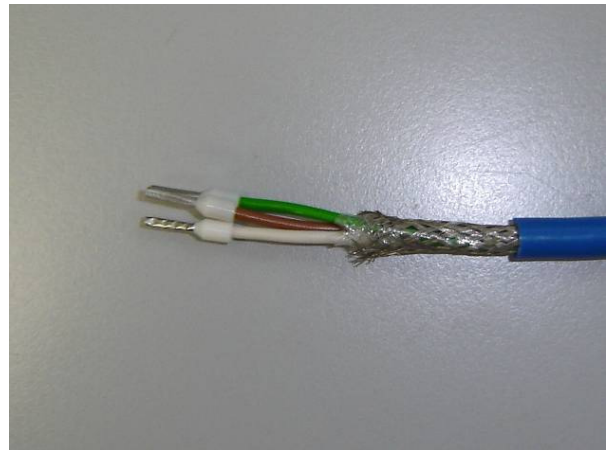

4: Remove the sheath over 20 mm

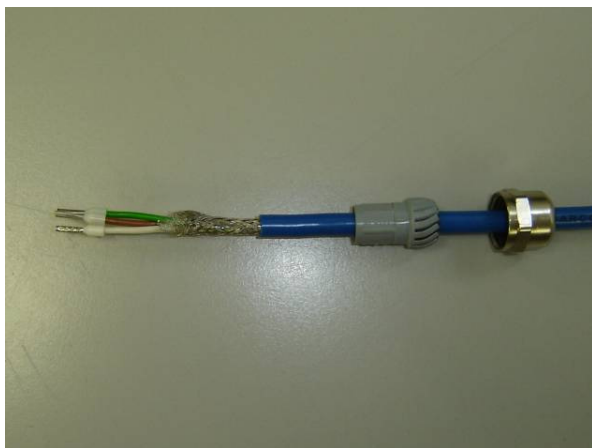

5: Take the nut and the seal from the gland and slide them over the cable

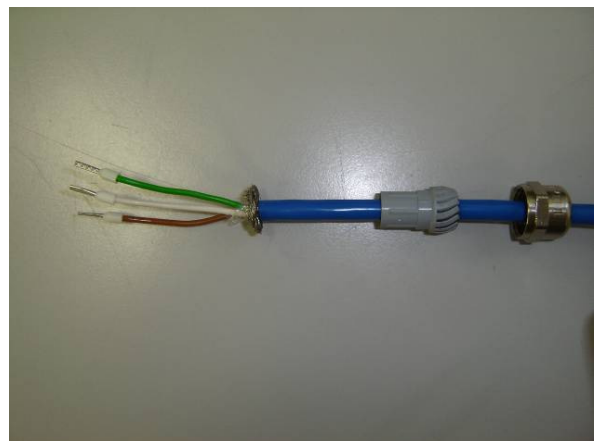

6: Press down the shield to fold it back

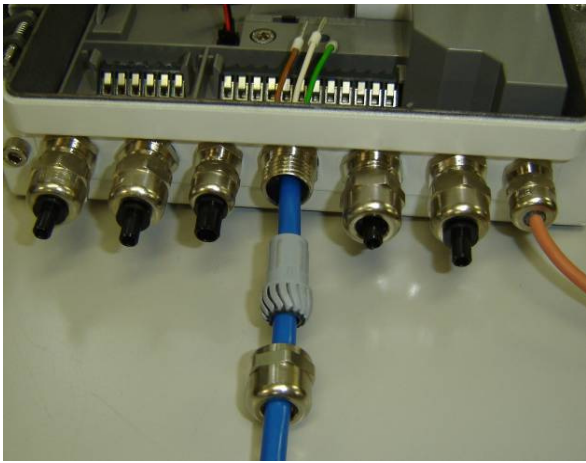

7: Press the cable into the cable gland until the shield is in the cable gland

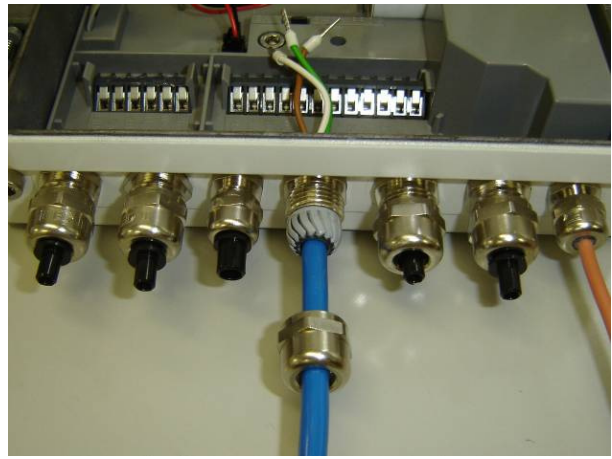

8: Press the seal into the cable gland and tighten it slightly

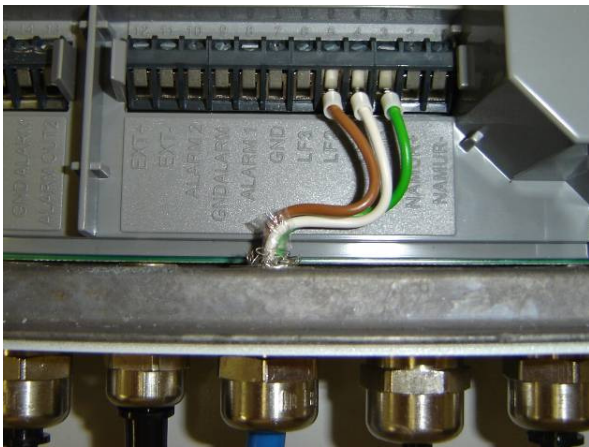

9: Tighten the nut and insert the cores into the terminal clamps

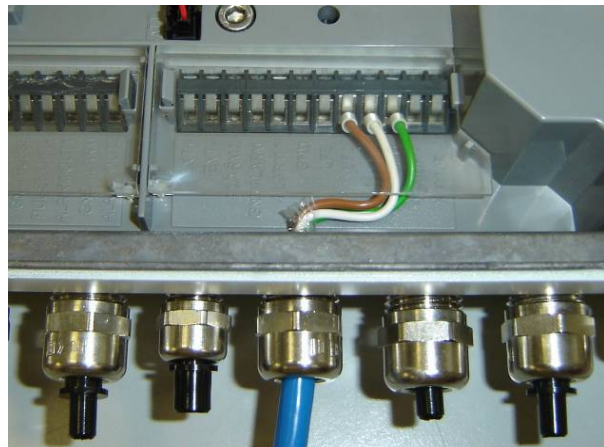

10: Place the transparent cover

4.5 Temperature sensor

The temperature sensor must be placed in a sensor pocket, see chapter 9 for an overview of available sensor pockets. If desired, the sensor pocket can be filled with thermal conduction paste. It is not permitted to cut the temperature sensor cable. Excess length must be tied up.



The sensor pocket is placed at the Tr reference measuring point of the gas meter or at a different position in the gas installation that meets the following criteria:

- distance to the gas meter: not exceeding 1 m
- position: downstream of the turbine gas meters
- insertion length: 1/3 to 2/3 of the internal diameter of the gas-carrying line

4.6 Pressure sensor

The pressure sensor should preferably be connected to the Pr reference measuring point of the gas meter. When using the external pressure sensor, it is not permitted to cut the cable. Excess cable length must be tied up.

For the purpose of testing, a Kamstrup BDA 04 or are three-way valve can be placed in the pressure measuring line.

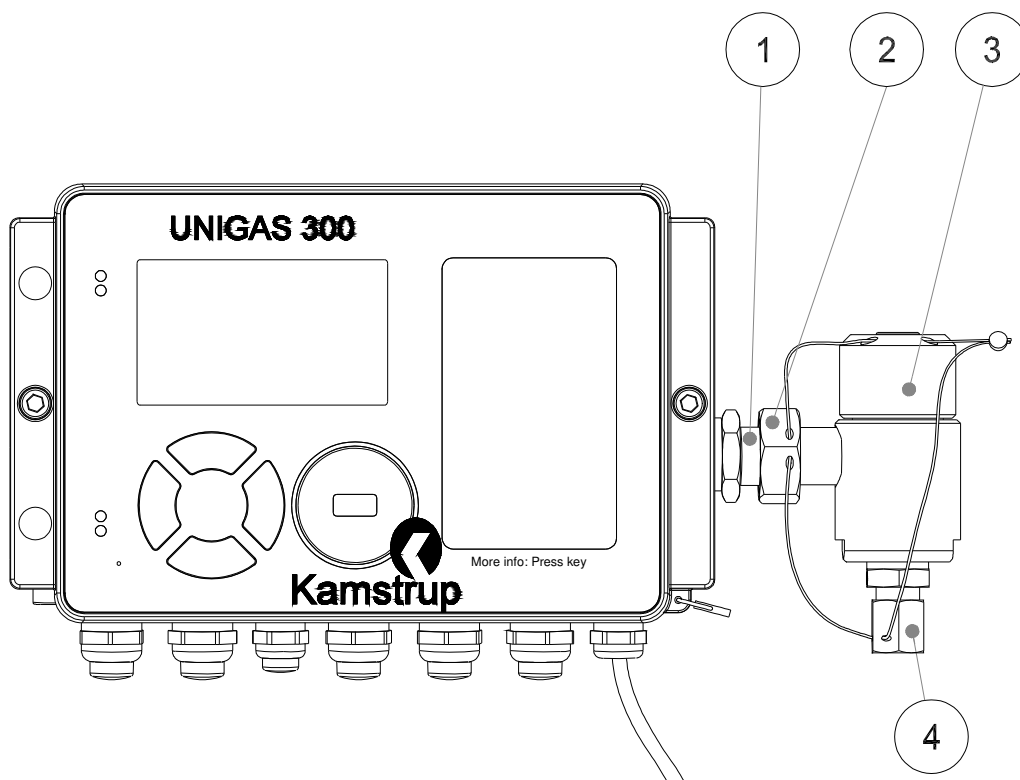

Figure 7. Mounting of BDA 04 with special connection adapter

A special connection adapter is supplied for mounting BDA 04 to UNIGAS 300.

Mount a BDA 04 as follows:

- 1: place the adapter ring (1) in the pressure sensor and tighten it;
- 2: place the BDA 04 (3) in the adapter ring (1);
- 3: lock the BDA 04 to prevent it from turning by tightening the nut (2);
- 4: mount the pressure measuring line to the cutting ring coupling (4) and connect the pressure;
- 5: place a security seal on the BDA 04 as shown in the figure above.

5 Sealing layout

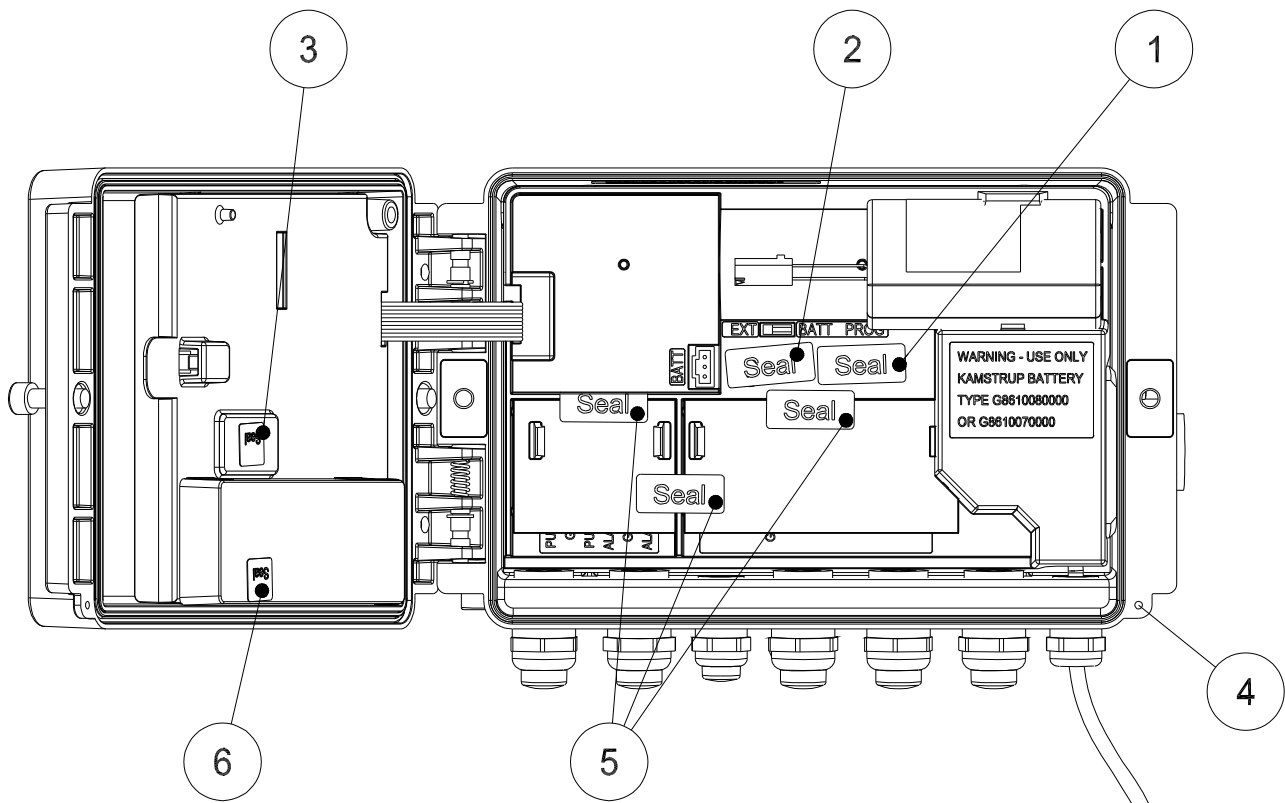

Figure 8. Calibration lock and optional housing seal

Figure 8 shows the positions for the seals:

- 1: adhesive seal for programming switch;
- 2: adhesive seal for access to bottom PCB;
- 3: adhesive seal for access to top PCB;
- 4: eye for sealing the housing (wire seal).

Optional sealing:

- 5: adhesive seal for input and output covers
- 6: adhesive seal for cover for module space

6 Control and display

UNIGAS 300 is simple to operate. Only four navigation keys allow easy navigation through the menu. Navigation keys ▼ and ▲ allow navigation between screens and menu functions. Navigation keys ► and ◀ are used to access or leave a menu or submenu. These navigation keys are also used to refresh or confirm certain data.

When not in use, the display is switched off to save energy. When one of the keys is operated, the first main screen will be displayed. Then ▼ will activate the second main screen or ► will activate the menu.

Chapter 10 provides a list of all available registers, complemented by a brief explanation and the position in the menu.

Main screens

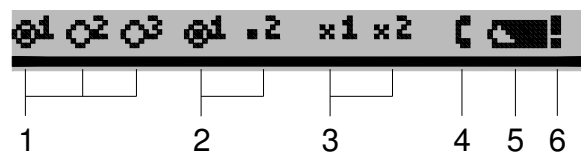

Figure 9. Main screen status bar

- 1: LF impulse input indicators of impulse inputs 1, 2, and 3
- 2: LF impulse output indicators of impulse outputs 1 and 2
- 3: alarm output indicators of alarm outputs 1 and 2
- 4: indicator for remote reading
- 5: battery condition indicator where a fully coloured symbol indicates a full battery and a less than fully coloured symbol indicates a partly empty battery. Check the value in UNIGAS 300 menu item 10. When the remaining capacity drops below 10 %, the battery condition indicator will start blinking, indicating that the battery has to be replaced. Dependent on the battery type and application, the remaining capacity is sufficient for 1 year (D cell) or 1.5 year (DD cell) of operation. Also see chapter 8.
- 6: indicator for calibration-relevant alarm. Check menu item 8.

Data for main screen 1

- Vm1: unconverted volume, total volume at measuring conditions, input 1
 Vb1: converted volume, undisturbed volume at base conditions, input 1

Data for main screen 2:

- Vc1: unconverted volume, undisturbed volume at measuring conditions and corrected for gas meter measuring error, input 1
 When operating with LF or encoder: $Vm1 = Vc1$
- Vc1err: unconverted volume, disturbed volume at measuring conditions, under circumstances of a calibration error condition and corrected for the gas meter measuring error, input 1
- Vb1_err: converted volume, disturbed volume at base conditions, under circumstances of a calibration error condition, input 1
- Vm2: unconverted volume, total volume at measuring conditions, input 2
- Vm3: unconverted volume, total volume at measuring conditions, input 3
- p: pressure of the natural gas flowing through the gas meter
- t: temperature of the natural gas flowing through the gas meter

Menu screen:



Figure 10. Elements of the menu screen

- 1: selected menu item
- 2: menu title
- 3: number of selected menu item
- 4: indicator that more screens can be displayed if ▼ or ▲ is actuated



Menu items can be switched off with UNITOOL. In such case, they will not be shown on the display.

Menu functions

| | | |
|-----------------------|---|--|
| 1. Current values | ▶ | 1-1: Cf, C, Z, Z/Zb, p, t. |
| 2. Parameters | ▶ | 2-1: CO, H, N, d, H, Z/Zbfix ▼ 2-2: tmeas, tb, pb ▼ 2-3: pmin, pmax, tmin, tmsx, pfix, tfix |
| 3. Flow rate | ▶ | 3-1: Qc1_5, Qc_nx5, Qc1_inst, Vc1_60. ▼ 3-2: Qb1_5, Qb1_nx5, Qb1_inst, Vb1-60. |
| 4. Interval logger | ▶ | 4-x: Date, date selection using ▼ and ▲ ▶ 4-x-1: interval, into for selection using ▼ and ▲ ▶ 4-x-x-x: Vm1, Vb1, Vc1, Vb1err ▶ ◀ 4-x-x-xa: Vm2, Vm3, t, p, status registers 1, 2, 3 |
| 5. Day logger | ▶ | 5-x: Day logger, day selection using ▼ and ▲ ▶ 5-x: Vm1, Vb1, Vc1, Vb1err ▶ ◀ 5-xa: Vm2, Vm3, t, p, status registers 1, 2, 3 |
| 6. Month logger | ▶ | 6-x: Month logger, month selection using ▼ and ▲ ▶ 6-x: Vm1, Vb1, Vc1, Vb1err ▶ ◀ 6-xa: Vm2, Vm3, t, p, status registers 1, 2, 3 |
| 7. Inputs and outputs | ▶ | 7-1: Inputs/outputs: INP1DIV, INP2DIV, INP3DIV, OUT1DIV, OUT2DIV |
| 8. Status | ▶ | 8: Status, actuating ▼ and ▲ and subsequently ▶ select a status register ▶ 8-1-x: Conversion; status register 1 Actuating ▶ resets the status register. An alarm cannot be reset until the cause of that alarm no longer exists ▶ 8-2-x: Operation; status register 2 ▶ 8-3-x: Alarm; status register 3 See chapter 10 for more information Remark: if there are no messages, that fact will be reported on the screen |
| 9. System | ▶ | 9-1: Serial, Version M, Version D, Operation, CRC M, CRC D ▼ 9-2: Gas meter, P meter, T meter, Time, Date ▼ 9-3: Dev addr, EAN code |
| 10. Battery | ▶ | 10-1: Status ▶ 10-1-1: Status: U batt, AH used, AH new ▶ 10-2: Replace See chapter 8, Replacing the battery |
| 11. Modem | ▶ | 11-1: Status: Network, Commh, Maincell, Ubatt ▶ 11-2: Switching on the modem, by actuating ▶ the modem is switched on for 30 min |
| 12. Adjusting | ▶ | 12-x: p_offset, tcorr_min, tcorr_0, tcorr_max See chapter 7; Maintenance |
| 13. Language | ▶ | 13-x: language setting English, Dutch, German ▼ and ▲ for selecting ▶ for activating ◀ to return |
| 14. Display test | ▶ | display with changing checker board pattern |

Remarks:

- When menu items 1 and 3 are selected, the measuring interval for pressure and temperature is temporarily reduced to 5 s.
- Menu numbers are given in grey.

Representation of status registers for menu items 4, 5, 6 and 8

UNIGAS 300 features three status registers:

- Status register 1; calibration-relevant alarms
- Status register 2; operation-relevant statuses
- Status register 3; other alarms and warnings

A status register contains a maximum of 16 alarms or warnings .

In menu item 8 the state of the alarms of status register 1 is retained until a manual reset has taken place. The alarms can only be reset, when the cause of the alarm no longer exists. By means of UNITOOL the reset action can be protected, see chapter 10, register C.93.14.

The state of the status registers is shown on the display as text messages in menus 8-1, 8-2 and 8-3.

In the presentation of interval data and data of the day and month loggers, menu items 4, 5 and 6, the three status registers are shown as three hexadecimal numbers of four characters:

$$\text{St} : 1_1 1_2 1_3 1_4 \quad 2_1 2_2 2_3 2_4 \quad 3_1 3_2 3_3 3_4$$

In the UNITOOL software the state (condition) of the status registers is represented in a comparable way, but pre leading 0 are not shown.

On the pages that follow, the three status registers are explained in more detail. The tables successively represent:

- the name with which a status message is shown in menu items 8-1, 8-2 and 8-3
- the classification of alarms or warnings for the presentation of St for menu items 4, 5 and 6
- the values of the presentation of St that belong to an alarm or warning
- the nature of the alarm or warning: C= condition (state) and E= event
- bit numbering as shown in UNITOOL when reading the status log book, see below
- description of the properties of the alarm or warning.

To determine the status on the basis of the presentation in menu items 4, 5 and 6, the value of a character is searched for in the three tables for each status register and character of that status register. Attention: A character can refer to more than one status messages.

Remark: Presentation of the status message of the status log book when reading by means of UNITOOL.

For each status bit change the status log book makes a report with time stamp. The report is presented by two numbers and the nature of the report. The presentation is in accordance with VDEW:

- the first number indicates the status register 1, 2 or 3
- the second number indicates the bit number in that status register, where bits 0 – 9 are indicated with 0 – 9 and bits 10 – 15 are indicated with A – E
- VDEW status: 0200 indicates that it involves an event, 0400 the beginning of a state and 0800 the end of a state.

Status register 1; calibration relevant alarms

St : 1₁1₂1₃1₄ 2₁2₂2₃2₄ 3₁3₂3₃3₄

| Presentation menu 8.1 | | Presentation menu 4, 5, 6 | | | Description |
|-----------------------|----------------|---------------------------|---|---|---|
| CRC error interface | 1 ₁ | 8, 9, A, B, C, D, E, F | E | F | CRC error occurred in program memory of the processor of the top PCB. The memory is checked once per hour |
| Watchdog interface | | 4, 5, 6, 7, C, D, E, F | E | E | Watchdog of the program of the processor of the top PCB has been activated |
| CRC error conversion | | 2, 3, 6, 7, A, B, E, F | E | D | CRC error occurred in program memory of the processor of the bottom PCB. The memory is checked once per hour |
| Watchdog conversion | | 1, 3, 5, 7, 9, B, D, F | E | C | Watchdog of the program of the processor of the bottom PCB has been activated |
| Reset | 1 ₂ | 8, 9, A, B, C, D, E, F | E | B | Software has been rebooted |
| External power | | 4, 5, 6, 7, C, D, E, F | C | A | External power supply present |
| Alarm ENCODER | | 2, 3, 6, 7, A, B, E, F | C | 9 | Readout values from encoder counter are unusable (BCC error) or a encoder reading is lower than counter reading Vm1 or Vm2. Vm1 or Vm1 will not be modified |
| NAMUR open circuit | | 1, 3, 5, 7, 9, B, D, F | C | 8 | NAMUR input has been interrupted. The current is lower than 1 mA. |
| NAMUR short-circuit | 1 ₃ | 8, 9, A, B, C, D, E, F | C | 7 | NAMUR input has a current greater than 8 mA, NAMUR input is switched off. |
| Counters set | | 4, 5, 6, 7, C, D, E, F | E | 6 | A counter reading has been set |
| Alarm switch program | | 2, 3, 6, 7, A, B, E, F | C | 5 | Calibration lock opened because calibration switch was operated |
| Alarm open casing | | 1, 3, 5, 7, 9, B, D, F | C | 4 | Housing is open |
| Alarm temperature | 1 ₄ | 8, 9, A, B, C, D, E, F | C | 3 | Measured value is not between tmin and tmax or measurement was not possible |
| Alarm pressure | | 4, 5, 6, 7, C, D, E, F | C | 2 | Measured value is not between pmin and pmax or measurement was not possible |
| Error Z of Zb | | 2, 3, 6, 7, A, B, E, F | C | 1 | Error on measuring Z or Zb |
| Low battery | | 1, 3, 5, 7, 9, B, D, F | C | 0 | Battery voltage too low (<2.8 V) or Ah_used > Ah_new State is ended when menu action exchange battery has been carried out and the battery voltage is at least 3.3 V |

C= condition and E= event

Status register 2; operational status

St : 1₁1₂1₃1₄ 2₁2₂2₃2₄ 3₁3₂3₃3₄

| Presentation menu 8.2 | | Presentation menu 4, 5, 6 | | | Description |
|-------------------------|----------------|---------------------------|---|---|---|
| Error in Zb | 2 ₁ | 8, 9, A, B, C, D, E, F | C | F | Error on calculation of Zb. This status bit is complementary to status bit error_Z_or_Zb |
| Error in p or t | | 4, 5, 6, 7, C, D, E, F | C | E | In status register 1 there is a report for alarm pressure and / or alarm temperature |
| Battery exchanged | | 2, 3, 6, 7, A, B, E, F | E | D | Battery exchanged through menu item 10-2 |
| Alarm volume difference | | 1, 3, 5, 7, 9, B, D, F | E | C | Volume difference measured between inputs 1 and 2 equal to or higher than value Vm1Vm2_warning. See chapter 17 for more details |
| Alarm tmax | 2 ₂ | 8, 9, A, B, C, D, E, F | C | B | Temperature > Alarm tmax |
| Alarm tmin | | 4, 5, 6, 7, C, D, E, F | C | A | Temperature < Alarm tmin |
| Alarm pmax | | 2, 3, 6, 7, A, B, E, F | C | 9 | Pressure > Alarm pmax |
| Alarm pmin | | 1, 3, 5, 7, 9, B, D, F | C | 8 | Pressure < Alarm pmin |
| Warning tmax | 2 ₃ | 8, 9, A, B, C, D, E, F | C | 7 | Temperature > Warning tmax |
| Warning tmin | | 4, 5, 6, 7, C, D, E, F | C | 6 | Temperature < Warning tmin |
| Warning pmax | | 2, 3, 6, 7, A, B, E, F | C | 5 | Pressure > Warning pmax |
| Warning pmin | | 1, 3, 5, 7, 9, B, D, F | C | 4 | Pressure < Warning pmin |
| Clock set | 2 ₄ | 8, 9, A, B, C, D, E, F | E | 3 | Clock set |
| Clock set > 10 s | | 4, 5, 6, 7, C, D, E, F | E | 2 | Clock has been moved by more than ns (register C.9.1) s, see also chapter 10, <i>Other settings for functions of UNIGAS 300</i> |
| Log book cleared | | 2, 3, 6, 7, A, B, E, F | E | 1 | Status log book or calibration log book erased |
| Logger cleared | | 1, 3, 5, 7, 9, B, D, F | E | 0 | Interval logger, day logger or month logger erased |

C= condition and E= event

Status register 3; other alarms and warnings

St : 1₁1₂1₃1₄ 2₁2₂2₃2₄ 3₁3₂3₃3₄

| Presentation menu 8.3 | | Presentation menu 4, 5, 6 | | | Description |
|-----------------------|----------------|---------------------------|---|---|---|
| | 3 ₁ | | | | No function |
| Log book (O) full | 3 ₂ | 8, 9, A, B, C, D, E, F | C | B | Status log book is full; the oldest loggings will be overwritten. Is cancelled as soon as log book is deleted. |
| Log book (M) full | | 4, 5, 6, 7, C, D, E, F | C | A | Calibration log book is full; the oldest loggings will be overwritten. Is cancelled as soon as log book is deleted. |
| Alarm input 2 | | 2, 3, 6, 7, A, B, E, F | C | 9 | Connected alarm contact open |
| Alarm input 1 | | 1, 3, 5, 7, 9, B, D, F | C | 8 | Connected alarm contact open |
| Warning Vc1_60 | 3 ₃ | 8, 9, A, B, C, D, E, F | C | 7 | Vc1_60 › Warning Vc1_60 |
| Alarm Vc1_60 | | 4, 5, 6, 7, C, D, E, F | C | 6 | Vc1_60 › Alarm Vc1_60 |
| Warning Qc1_nx5 | | 2, 3, 6, 7, A, B, E, F | C | 5 | Qc1 › Warning Qc1_nx5 |
| Alarm Qc1_nx5 | | 1, 3, 5, 7, 9, B, D, F | C | 4 | Qc1 › Alarm Qc1_nx5 |
| Warning Vb1_60 | 3 ₄ | 8, 9, A, B, C, D, E, F | C | 3 | Vb1_60 › Warning Vb1_60 |
| Alarm Vb1_60 | | 4, 5, 6, 7, C, D, E, F | C | 2 | Vb1_60 › Alarm Vb1_60 |
| Warning Qb1_nx5 | | 2, 3, 6, 7, A, B, E, F | C | 1 | Qb1 › Warning Qb1_nx5 |
| Alarm Qb1_nx5 | | 1, 3, 5, 7, 9, B, D, F | C | 0 | Qb1 › Alarm Qb1_nx5 |

C= condition and E= event

7 Maintenance

7.1 Adjusting

Menu item 12 in UNIGAS 300 can be used to adjust the temperature sensor and/or the pressure sensor to increase the measurement accuracy.

The pressure sensor can be adjusted with an offset value (p_offset). Modifying this value will result in that the measured pressure over the entire range is increased or decreased by this value.

The temperature sensor can be adjusted by an offset value (tcorr_0) and by entering a span. This span can be set for the measuring range from -40 °C to 0 °C (tcorr_min.) and for the measuring range from 0 to 55 °C (tcorr_max).

As a rule, tcorr_0 is set at -0.24 °C for correction of the 3-m length of cable with which the temperature sensor is connected.

The value of span is expressed in °C/°C and can be determined as follows (X °C is a random temperature higher than 0 °C or a random temperature below 0 °C):

$$\text{Span} = \frac{\text{deviation at X °C} - \text{deviation at 0 °C}}{X °C - 0 °C}$$

Proceed as follows:

| | |
|---------------|---|
| 12. Adjusting | <p>▶ Screen 12-x: p_offset, tcorr_min, tcorr_0, tcorr_max</p> <p>▶ for activating, value starts blinking</p> <p style="padding-left: 40px;">▼ and ▲ to modify the value</p> <p style="padding-left: 40px;">▶ confirm, confirmation will only be accepted if the programming switch is operated simultaneously. The value will stop blinking.</p> <p style="padding-left: 40px;">◀ to return</p> |
|---------------|---|

7.2 Replacing the pressure sensor or the temperature sensor

The seal must be broken in order to replace the pressure sensor or the temperature sensor. Then unscrew the bolt, see chapter 4, fig. 5, item 5.

Now remove the battery, the cables to the terminal strip and the protective cover.

Replace the pressure sensor or the temperature sensor and put the protective cover and the cables back in place. Finally, put the battery back. When the housing is closed, UNIGAS 300 will automatically take over the data from the pressure sensor. This can be checked by the serial number, see menu item 9 (System).

Subsequently, UNIGAS 300 must be checked for accuracy. As the power to UNIGAS 300 has been interrupted, it must be checked whether the clock is running correctly. If necessary, the clock must be set.

Replacing the temperature sensor

See figure 11.

1A: Unscrew the nut from the cable gland.

1B: Press with a finger on the clamping mechanism on the terminal strips to uncouple the cable connections of the temperature sensor.

Mount the replacement temperature sensor in the reverse order.

Check the set values in menu item 12, see chapter 7.1. For a new temperature sensor `tcorr_0` must be set at -0.24 °C. This value is to correct the 3-m cable of the temperature sensor.

Replacing the internal pressure sensor

See figure 11.

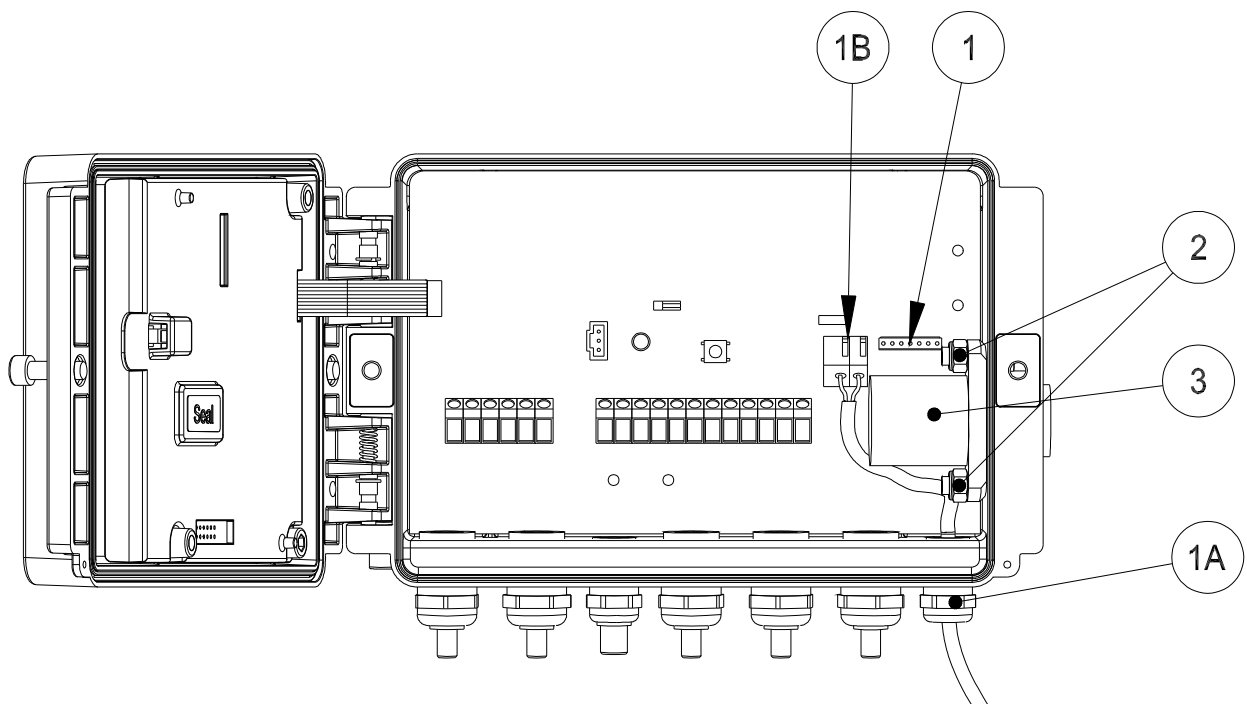

Figure 11. Replacing the temperature sensor and the internal pressure sensor

1: Unscrew the connector from the pressure sensor.

2: Unscrew the bolts and carefully take them from the housing. Two bushes with O-washers are placed on the bolts.

3: Then carefully push on the pressure sensor to take it out from the inside.

Mount the replacement pressure sensor in the reverse order.

Replacing the external pressure sensor

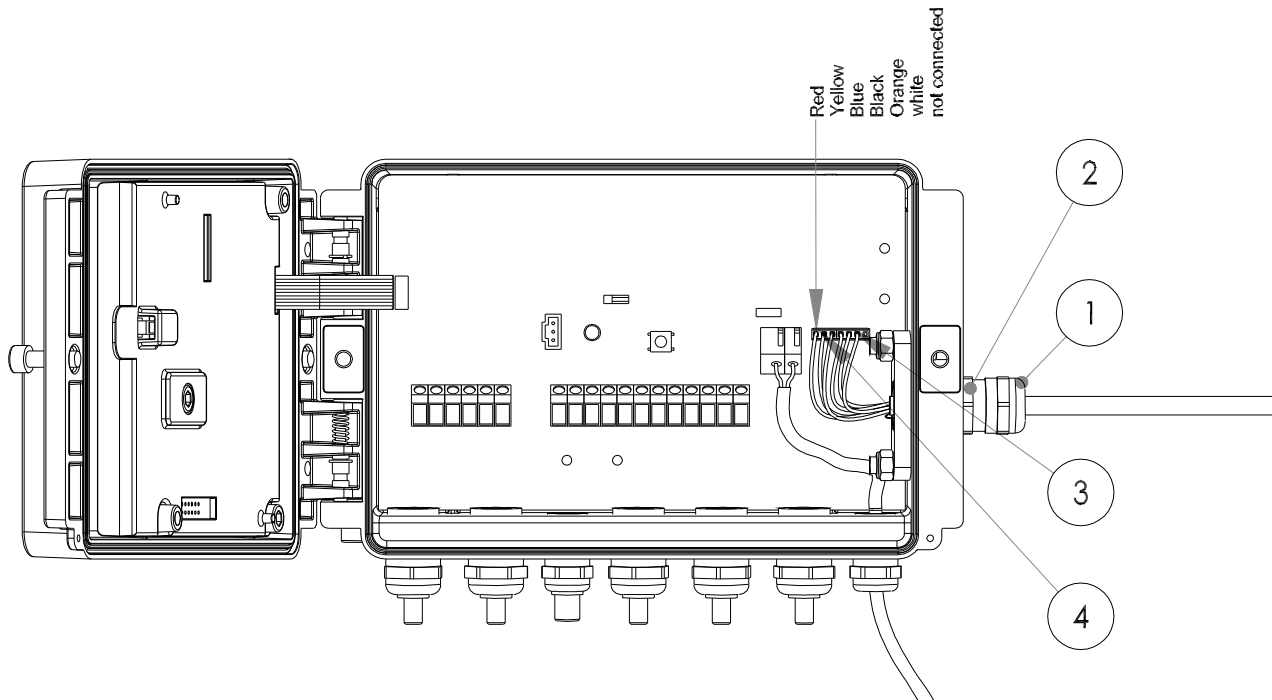

Figure 12. Replacing the external pressure sensor

The pressure sensor comes with a cable gland and mounted connectors. Take out the pressure sensor to be replaced as indicated below and mount the replacement pressure sensor in the reverse order. When exchanging an external pressure sensor, the shield of the pressure sensor cable must be connected with the bush in the cable gland, see chapter 4.3.

- 1: Unscrew the cable gland nut and take out the inner bush by pulling it out of the cable gland.
- 3, 4: Take out both connectors.
- 2: Unscrew the cable gland nut and then take the external pressure sensor from UNIGAS 300.

8 Replacing the battery



Batteries must only be replaced by original batteries of type G8610070000 or G8610080000 supplied by Kamstrup. It is permitted to replace the battery in a potentially explosive atmosphere. Put UNIGAS 300 into sleep mode through menu item 10 prior to replacing the battery. UNIGAS 300 can remain operational in sleep mode for about 17 s without battery (for safety reasons the display will indicate 10 s). During sleep mode, UNIGAS 300 will not carry out any conversion. The clock does keep running. After sleep mode UNIGAS 300 will activate itself and all functions will become active again.

If replacing the battery takes longer than this sleep mode period, UNIGAS 300 will shut down. The moment UNIGAS 300 gets powered again, UNIGAS 300 will start up with the most recent backup data. UNIGAS 300 makes a backup every 5-min interval, so the information will not be older than 5 min. The power failure will be logged in status register 1 and the clock will have to be set again.

Data for battery type G8610070000

- Lithium-Thionyl chloride: D cell
- Nominal voltage: 3.6 V
- Nominal capacity: 18.5 Ah
- Initial capacity to be entered into UNIGAS 300: 12 Ah (applicable in Western Europe)

Data for battery type G8610080000

- Lithium-Thionyl chloride: DD cell
- Nominal voltage: 3.6 V
- Nominal capacity: 35 Ah
- Initial capacity to be entered into UNIGAS 300: 21 Ah (applicable in Western Europe)

Observe the procedure below before the battery is replaced.

- Check that the packaging of the new battery is still unopened and that the production date on the battery is not further back than 2 years before the current date. Open the packaging and keep the battery within easy reach.
- Unscrew the two bolts on the front of UNIGAS 300 until the bolt heads are roughly level with the front. Then open the housing. The seal may stick, so it may take some effort to open the housing. Then close the housing, but do not tighten the bolts yet.
- Select menu item 10 (battery) on the display and perform the actions given below:

| | | |
|-------------|---|--|
| 10. Battery | ▶ | Screen 10-1: Status ▶ Screen 10-1-1: Status: U batt, AH used, AH new ▶ Screen 10-2: Replace ▶ Screen 10-2-2: Replace now ▶ Screen 10-2-2-1: Open cover and replace battery within 10 s |
|-------------|---|--|

- UNIGAS 300 is set to sleep mode at the moment when the housing is opened. That shows from the display going blank. Now first take the battery connector from UNIGAS 300. Then quickly place the connector of the new battery. Now take the old battery from the battery holder and place the new battery in the battery holder.

Remark: If the opening of the housing takes too long, UNIGAS 300 will break off the procedure. When the housing is opened, the display will not go blank. Repeat the procedure.

- Close the housing of UNIGAS 300, screw the housing tight and operate the push buttons to check the functions of UNIGAS 300.



Only when a battery is replaced by another type of battery (for the values to be set, see above) the initial capacity shall be set subsequently:

| | | |
|-------------|---|--|
| 10. Battery | ▶ | Screen 10-1: Status ▶ Screen 10-1-1: Status: U batt, AH used, AH new ▶ Screen 10-2: Replace ▶ Screen 10-2-1: Initial capacity ▶ Screen 10-2-1-1: Ah ▶ for activating, value starts blinking ▼ and ▲ to modify the value ▶ to confirm ◀ to return |
|-------------|---|--|

Careful

The battery must not be recharged or short-circuited.



Used batteries must be sent to a certified processing company.

9 Sensor pockets for temperature sensor

Available models:

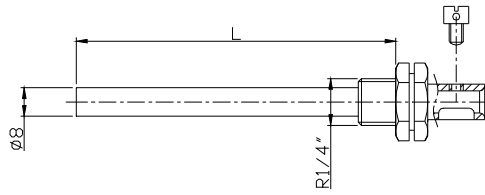

| L (mm) | Best. Nr. |
|--------|-----------|
| 65 | GG8702 |
| 81 | GG8703 |
| 105 | GG8704 |
| 151 | GG8705 |
| 157 | GG8706 |
| 167 | GG8707 |

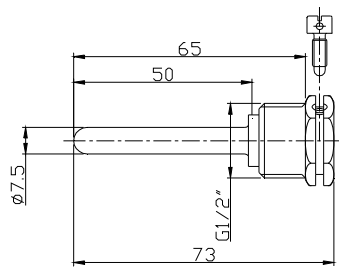

| L (mm) | Best. Nr. |
|--------|-----------|
| 65 | GG8320 |

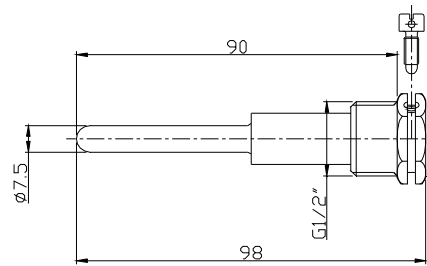

| L (mm) | Best. Nr. |
|--------|-----------|
| 90 | GG8321 |

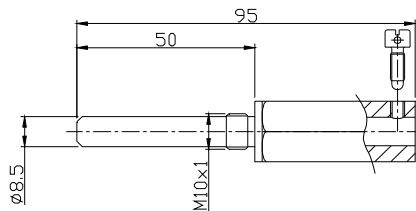

| L (mm) | Best. Nr. |
|--------|-----------|
| 50 | GG8708 |

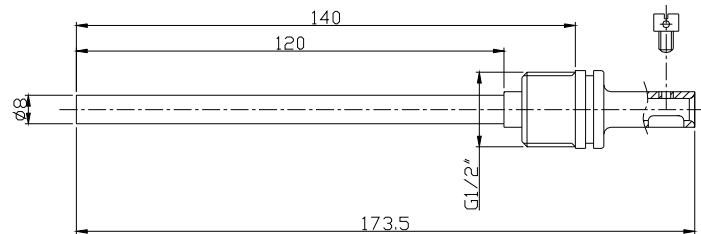

| L (mm) | Best. Nr. |
|--------|-----------|
| 140 | GG8322 |

10 Counters and registers

The counters and registers present in UNIGAS 300 are listed below. The name of each counter or register is indicated together with the OBIS code, the protection level and a summary description. Where applicable, the names used are in accordance with standard EN 12405-1.

All counters and registers can be read out with the UNITOOL software (dependent on the rights assigned in UNITOOL).

The column *Menu item* shows the corresponding menu item number, if these data are also shown through the display of UNIGAS 300.

Counters and registers may be provided with write protection.

The following protection levels are available in UNIGAS 300.

- Calibration lock: writing is only possible if the programming switch is operated during writing.
- Protection level 1: password 1 gives access to the programming mode in which counters and registers can be read and written to. Password 1 is protected by password 2a.
- Protection level 2a: password 2a allows writing to registers. Password 2a is assigned to the gas supplier and has the same function as the VDEW password. Password 2a is protected by password 2a.
- Protection level 2b: password 2b allows writing to registers. Password 2b is assigned to the gas consumer. Password 2b is protected by password 2b.

If no passwords have been programmed, registers can be accessed and written to without the use of passwords or the use of any password.

Passwords are both read-protected and write-protected.

Counter readings

Protection level: calibration lock

| Name | Unit | Menu item | OBIS code | Description |
|---------|----------------|-------------|------------|---|
| Vm1 | m ³ | Main menu 1 | 7-1:13.0.0 | unconverted volume, total volume at measuring conditions, input 1 |
| Vc1 | m ³ | Main menu 2 | 7-1:11.1.0 | unconverted volume, undisturbed volume at measuring conditions and corrected for gas meter measuring error, input 1. When operating with LF or encoder: Vm1 = Vc1 |
| Vc1_err | m ³ | Main menu 2 | 7-1:12.0.0 | unconverted volume, disturbed volume at measuring conditions, under circumstances of a calibration error condition and corrected for the gas meter measuring error, input 1 |
| Vb1 | m ³ | Main menu 1 | 7-1:11.2.0 | converted volume, undisturbed volume at base conditions, input 1 |
| Vb1_err | m ³ | Main menu 2 | 7-1:12.1.0 | converted volume, disturbed volume at base conditions, under circumstances of a calibration error condition, input 1 |
| Vm2 | m ³ | Main menu 2 | 7-2:13.0.0 | unconverted volume, total volume at measuring conditions, input 2 |
| Vm3 | m ³ | Main menu 2 | 7-3:13.0.0 | unconverted volume, total volume at measuring conditions, input 3 |

Processed counter readings; consumption values recorded for input 1

| Name | Unit | Menu item | OBIS code | Description |
|----------|-------------------|-----------|-------------|--|
| Qc1_5 | m ³ /h | 3-1 | 7-1:43.1.1 | Flow at measuring conditions based upon 5 minutes interval, total value |
| Qc1_nx5 | m ³ /h | 3-1 | 7-1:43.1.2 | Flow at measuring conditions, based upon the moving average of n x 5 minutes interval, total value |
| Qc1_inst | m ³ /h | 3-1 | 7-1:43.1.0 | Instantaneous flow rate, corrected and unconverted total value |
| Vc1_60 | m ³ | 3-2 | 7-1:43.1.71 | Consumption in actual hour, total volume at measuring conditions |
| Qb1_5 | m ³ /h | 3-2 | 7-1:43.2.1 | Flow at base conditions, undisturbed value based upon 5 minutes interval |
| Qb1_nx5 | m ³ /h | 3-2 | 7-1:43.2.2 | Flow at base conditions, undisturbed value based upon the moving average of n x 5 minutes interval |
| Qb1_inst | m ³ /h | 3-2 | 7-1:43.2.0 | Instantaneous flow, undisturbed value at measuring conditions |
| Vb1_60 | m ³ | 3-2 | 7-1:43.2.71 | Consumption in actual hour, undisturbed volume |

Miscellaneous functions, protection level 2b

| Name | Unit | OBIS code | Description |
|-------------------------|------|-----------|---|
| Flow rate measurement n | - | C.93.1 | Time base for determining flow rate Q based on the moving average of n units of 5 min |

Objects resulting from the conversion / measured values

| Name | Unit | Menu item | OBIS code | Description |
|------|------|-----------|------------|---|
| Cf | - | 1-1 | 7-1:51.0.0 | Current correction value of the gas meter measuring error |
| C | - | 1-1 | 7-1:52.2.0 | Calculated conversion factor |
| Z | - | 1-1 | 7-1:53.0.0 | Gas compressibility under operating conditions |
| Z/Zb | - | 1-1 | 7-1:53.2.0 | Gas compressibility factor |
| p | mbar | 1-1 | 7-1:42.0.0 | Pressure |
| t | °C | 1-1 | 7-1:41.0.0 | Temperature |

Objects/parameters that define the conversion, inputs and correction of the gas meter measuring error

Protection level: calibration lock

| Name | Unit | Menu item | OBIS code | Description |
|-----------|--------------------|-----------|-----------|---|
| INP1DIV | imp/m ³ | 7-1 | 7-1:0.7.2 | Scaling factor for input 1 |
| INPHFIDIV | imp/m ³ | 7-1 | 7-4:0.7.2 | Scaling factor for input 1 if this is set for HF impulses |
| INP2DIV | imp/m ³ | 7-1 | 7-2:0.7.2 | Scaling factor for input 2 |
| INP3DIV | imp/m ³ | 7-1 | 7-3:0.7.2 | Scaling factor for input 3 |
| Input 1 | - | | C.93.9 | Functionality of input 1: LF, HF, encoder and encoder at Vm2 For <i>Encoder at Vm2</i> , Vm1 counts LF impulses presented at LF1 input. In Vm2 the encoder reading is counted on the basis of 5-min interval reading |
| Cf1 | - | | C.98.1 | Factor 1 for measuring error correction of gas meter. Between Qf1 and Qf2 linear interpolation takes place between Cf1 and Cf2 |
| Qf1 | m ³ /h | | C.98.2 | Qf1 where Qf1= Q _{min} gas meter (see EN12405-1) |
| Cf2 | - | | C.98.3 | Factor 2 for measuring error correction of gas meter. Between Qf2 and Qf3 linear interpolation takes place between Cf2 and Cf3 |
| Qf2 | m ³ /h | | C.98.4 | Qf2 where Qf1 < Qf2 < Qf3 |
| Cf3 | - | | C.98.5 | Factor 3 for measuring error correction of gas meter. Between Qf3 and Qf4 linear interpolation takes place between Cf3 and Cf4 |
| Qf3 | m ³ /h | | C.98.6 | Qf3 where Qf2 < Qf3 < Qf4 |
| Cf4 | - | | C.98.7 | Factor 4 for measuring error correction of gas meter. Between Qf4 and Qf5 linear interpolation takes place between Cf4 and Cf5 |
| Qf4 | m ³ /h | | C.98.8 | Qf4 where Qf3 < Qf4 < Qf5 |
| Cf5 | - | | C.98.9 | Factor 5 for measuring error correction of gas meter. Outside the range of Qf5 correction takes place with Cf5 |
| Qf5 | m ³ /h | | C.98.10 | Qf5 where Qf4 < Qf5 < Q 6 |
| Cf6 | - | | C.98.11 | Factor 6 for measuring error correction of gas meter. Between Qf6 and Qf7 linear interpolation takes place between Cf6 and Cf7 |
| Qf6 | m ³ /h | | C.98.12 | Qf6 where Qf5 < Qf6 < Qf7 |
| Cf7 | - | | C.98.13 | Factor 7 for measuring error correction of gas meter. Between Qf7 and Qf8 linear interpolation takes place between Cf7 and Cf8 |
| Qf7 | m ³ /h | | C.98.14 | Qf7 where Qf6 < Qf7 < Qf8 |
| Cf8 | - | | C.98.15 | Factor 8 for measuring error correction of gas meter. Between Qf8 and Qf9 linear interpolation takes place between Cf8 and Cf9 |
| Qf8 | m ³ /h | | C.98.16 | Qf8 where Qf7 < Qf8 < Qf9 |
| Cf9 | - | | C.98.17 | Factor 9 for measuring error correction of gas meter. Between Qf9 and Qf10 linear interpolation takes place between Cf9 and Cf10 |
| Qf9 | m ³ /h | | C.98.18 | Qf9 where Qf8 < Qf9 < Qf10 |
| Cf10 | - | | C.98.19 | Factor 10 for measuring error correction of gas meter. If Q > Q10 is corrected with value Qf10 |
| Qf10 | m ³ /h | | C.98.20 | Qf10 where Qf10= Q _{min} gas meter (see EN12405-1) |

Pressure sensor, temperature sensor and gas meter

Protection level: calibration lock

| Name | Unit | Menu item | OBIS code | Description |
|-----------|-----------|-----------|------------|---|
| p_offset | mbar | 12-1 | C.97.1 | Value used to correct the measured pressure: $p_{corrected} = p + p_offset$ Remark: if a different pressure sensor is connected p_offset will be reset |
| tcorr_min | - (°C/°C) | 12-2 | C.97.3 | Correction value for t in the range $t_{min} - 0\text{ °C}$: $t_{corrected} = t + tcorr_0 + (0\text{ °C} - t) \times tcorr_min$ |
| tcorr_0 | °C | 12-3 | C.97.4 | Offset at 0 °C |
| tcorr_max | - (°C/°C) | 12-4 | C.97.5 | Correction value for t in the range $0\text{ °C} - t_{max}$: $t_{corrected} = t + tcorr_0 + (t - 0\text{ °C}) \times tcorr_max$ |
| pmin | mbar | 2-3 | C.97.6 | Minimum pressure of the pressure range within which conversion takes place |
| pmax | mbar | 2-3 | C.97.7 | Maximum pressure of the pressure range within which conversion takes place |
| tmin | °C | 2-3 | C.97.8 | Minimum temperature of the temperature range within which conversion takes place |
| tmax | °C | 2-3 | C.97.9 | Maximum temperature of the temperature range within which conversion takes place |
| pfix | mbar | 2-3 | 7-1:42.3.0 | Fixed value for the pressure used for conversion for a UNIGAS 300 T or TZ version Fixed value used for conversion in the event of pressure sensor failure Fixed value used for conversion when the measured pressure comes outside the range pmin to pmax |
| tfix | °C | 2-3 | 7-1:41.3.0 | Fixed value for the temperature used for conversion in the event of temperature sensor failure Fixed value used for conversion when the measured temperature comes outside the range tmin to tmax |
| gas meter | - | 9-2 | 7-1:0.2.14 | Serial number of the connected gas meter |
| p meter | - | 9-2 | 7-1:0.2.11 | Serial number of pressure sensor; it will be automatically read from the connected pressure sensor |
| t meter | - | 9-2 | 7-1:0.2.12 | Serial number of temperature sensor; it is programmed after the sensor has been mounted |

Gas composition and conversion

Protection level: calibration lock

| Name | Unit | Menu item | OBIS code | Description |
|--------------------------------------|-------------------|-----------|-------------|--|
| CO ₂ * | mol % | 2-1 | C.96.1 | Carbon dioxide concentration CO ₂ |
| H ₂ * | mol % | 2-1 | C.96.2 | Hydrogen concentration H ₂ |
| N ₂ * | mol % | 2-1 | C.96.3 | Nitrogen concentration N ₂ |
| d* | - | 2-1 | 7-1:45.11.0 | Relative density compared to air at 0 °C |
| H _s * | MJ/m ³ | 2-1 | 7-1:54.11.0 | Calorific value of 1 m ³ gas at 25 °C |
| Z/Zbfix | - | 2-1 | 7-1:53.3.0 | Fixed value used for conversion in the event of alarm_Z_or_Zb Fixed value used for conversion for UNIGAS 300 T and PT version |
| tmeasure | s | 2-2 | 7-1:0.8.5 | Measuring interval for measuring pressure and temperature and calculation of Z and conversion factor C |
| tb | °C | 2-2 | 7-1:41.2.0 | Reference temperature (base conditions) |
| pb | mbar | 2-2 | 7-1:42.2.0 | Reference pressure (base conditions) |
| Calibration lock for gas parameters* | - | | C.93.22 | Selector switch to switch off calibration lock for gas parameters CO ₂ , H ₂ , N ₂ , d and H _s . Options: <ul style="list-style-type: none"> ○ calibration lock on (factory-set) ○ calibration lock off ○ calibration lock off on condition that the calibration log book is not yet full (contents overwriting). |

* As from software version 1.3.11 and up it is possible to switch off the calibration lock for these registers to enable remote programming. To do this, register C.93.22 shall be set by means of UNITOOL. The following conditions apply:

- If the calibration lock is switched off, protection level 1 must be active.

Peak registers

| Name | Unit | OBIS code | Description |
|----------------------|-------------------|-----------|---|
| pmax yesterday | mbar | C.95.1 | Maximum value of pressure p, yesterday |
| tmax yesterday | °C | C.95.2 | Maximum value of temperature t, yesterday |
| pmin yesterday | mbar | C.95.3 | Minimum value of pressure p, yesterday |
| tmin yesterday | °C | C.95.4 | Minimum value of temperature t, yesterday |
| Qc_nx5 yesterday | m ³ /h | C.95.5 | Maximum value of Qc_nx5, yesterday |
| Qb_nx5 yesterday | m ³ /h | C.95.6 | Maximum value of Qb_nx5, yesterday |
| Qc_nx5 last month | m ³ /h | C.95.15 | Maximum value of Qc_nx5, last month |
| Qb_nx5 last month | m ³ /h | C.95.16 | Maximum value of Qb_nx5, last month |
| Qc_nx5 last year | m ³ /h | C.95.25 | Maximum value of Qc_nx5, last year |
| Qb_nx5 last year | m ³ /h | C.95.26 | Maximum value of Qb_nx5, last year |
| Qc_nx5 current month | m ³ /h | C.95.45 | Maximum value of Qc_nx5, last month |
| Qb_nx5 current month | m ³ /h | C.95.46 | Maximum value of Qb_nx5, last month |
| Qc_nx5 current year | m ³ /h | C.95.55 | Maximum value of Qc_nx5, last year |
| Qb_nx5 current year | m ³ /h | C.95.56 | Maximum value of Qb_nx5, last year |

Impulse outputs

Protection level 1: password 2b

| Name | Unit | Menu item | OBIS code | Description |
|------------------|---------------------|-----------|-----------|---|
| OUT1_div | m ³ /imp | 7-1 | C.94.1 | Scaling factor for impulse output 1, configurable from 1 to 100 |
| OUT2_div | m ³ /imp | 7-1 | C.94.2 | Scaling factor for impulse output 2, configurable from 1 to 100 |
| Impulse output 1 | - | | C.93.2 | Selector switch for impulse output 1 |
| Impulse output 2 | - | | C.93.3 | Selector switch for impulse output 2 |

Settings for alarm messages and warnings

Protection level 1: password 2b

| Name | Unit | OBIS code | Description |
|-----------------|-------------------|-----------|---|
| Alarm Qb1_nx5 | m ³ /h | C.92.1 | Trigger value for alarm Qb1_nx5 |
| Warning Qb1_nx5 | m ³ /h | C.92.2 | Trigger value for warning Qb1_nx5 |
| Alarm Vb1_60 | m ³ | C.92.3 | Trigger value for alarm Vb1_60 |
| Warning Vb1_60 | m ³ | C.92.4 | Trigger value for warning Vb1_60 |
| Alarm Qc1_nx5 | m ³ /h | C.92.5 | Trigger value for alarm Qc1_nx5 |
| Warning Qc1_nx5 | m ³ /h | C.92.6 | Trigger value for warning Qc1_nx5 |
| Alarm Vc1_60 | m ³ | C.92.7 | Trigger value for alarm Vc1_60 |
| Warning Vc1_60 | m ³ | C.92.8 | Trigger value for warning Vc1_60 |
| Alarm Vm2-Vm1 | m ³ | C.92.9 | Trigger value at volume difference between inputs 1 & 2 If = 0, this function is deactivated |
| Warning pmin | mbar | C.92.10 | Trigger value for warning of minimum pressure |
| Warning pmax | mbar | C.92.11 | Trigger value for warning of maximum pressure |
| Warning tmin | °C | C.92.12 | Trigger value for warning of minimum temperature |
| Warning tmax | °C | C.92.13 | Trigger value for warning of maximum temperature |

Remark: The function is deactivated if the value 0 is programmed for the alarms and warnings for flow rate and hourly consumption.

Service registers

The service registers can only be read through the serial ports, for instance using UNITOOL software

| Name | Unit | Menu item | OBIS code | Description |
|--------------------------|------|-----------|-----------|--|
| Appliance type | - | | C.1.1 | Object shows the conversion algorithm and the version, configuration display: S1S2 S1 = SGERG1 / SGERG2 / SGERG3 / SGERG4 / AGA19 / AGA8 S2 = T / TZ: / PT / PTZ |
| Serial number | - | 9-1 | C.1.0 | Serial number UNIGAS 300 |
| Version M | - | 9-1 | 7-0:0.2.0 | Firmware version present in bottom PCB |
| Version D | - | 9-1 | 7-0:0.2.1 | Firmware version present in top PCB |
| Operation | h | 9-1 | C.8.0 | Number of operating hours of UNIGAS 300 |
| CRC M | - | 9-1 | C.91.3 | 16-bit CRC value of the program memory for calibration functions, is determined every 24-h interval |
| CRC D | - | 9-1 | C.91.4 | 16-bit CRC value of the program memory for display and communication functions, is determined every 24-h interval |
| U_batt | mV | 10-1-1 | C.6.3 | Battery voltage of UNIGAS 300 |
| Ah_used | Ah | 10-1-1 | C.6.1 | Battery capacity used by UNIGAS 300. This value will be reset when the battery is replaced through menu item 10-2 |
| Ah_new | Ah | 10-1-1 | C.6.4 | Available capacity battery in new condition. See chapter 8; <i>Replacing the battery</i> Adjustable through menu item 10 |
| Bottom PCB serial number | - | | C.91.5 | Serial number of bottom PCB (calibration) |
| Analog1 | - | | C.90.20 | Ratiometric value of A/D-converter with a reference voltage of module connector |
| Top PCB serial number | - | | C.91.6 | Serial number of top PCB (display and communication) |
| Main cell (GSM) | - | 11-1-1 | C.90.7 | Power of GSM main cell expressed as aa,bb aa: signal strength reception 0: -113 dB _m or less 1 - 30: signal strength (dBm)= -113 + 2 x aa 31: -51 dB _m or higher 99: no value available bb: channel bit error rate 0...7: RXQUAL according to table GSM 05.08 99: no value available |
| Ubatt (GSM) | mV | 11-1-1 | C.90.6 | Battery voltage connected UNILOG |
| Networkh (GSM) | h | 11-1-1 | C.90.4 | Number of hours connected with a GSM network |
| Commh (GSM) | h | 11-1-1 | C.90.5 | number of hours of GSM communication |
| Ah_used_GSM | Ah | | C.90.21 | Used battery capacity of the battery of connected UNILOG |
| Module_type | | | C.91.7 | Identification of type of module placed in UNIGAS 300 |

Other settings for functions of UNIGAS 300

Protection level 1: password 2b

| Name | Unit | Menu item | OBIS code | Description |
|---------------------------------|--------|-----------|-----------|---|
| ns | s | | C.91.1 | Maximum deviation of the clock in UNIGAS 300 that may be corrected, if the correction value is greater than ns, status bit clock_set is written; ns is set as standard at 10 s |
| Gas day | h | | C.91.2 | Moment at which UNIGAS 300 closes and logs the day, as in day logger (end of gas day) |
| Time | hhmmss | 9-2 | 0.9.1 | Current time |
| Date | ddmmyy | 9-2 | 0.9.2 | Current date |
| EAN code | | 9-3 | C.96.0 | Meter location code (client-specific) |
| Dev addr | | 9-3 | C.90.1 | Device address for IEC 62056-21 communication protocol, if no device address is set, the device address equals 00000000 (the device will respond to any device address or to no device address) |
| Device_adress_61E | | | C.90.26 | Device address on which UNIGAS 300 will respond as a UNIGAS 61 E. |
| Presentation display clock | | | C.93.6 | Selector switch for use of clock on display in summer or winter time |
| Presentation protocol clock DST | | | C.93.7 | Selector switch for use of clock communication protocol in summer or winter time |
| Use scheduler clock DST | | | C.93.8 | Selector switch for use of clock of scheduler in summer or winter time |
| Scheduler modem control | | | C.93.12 | Selector switch for control modem scheduler of UNILOG MU, control I/O of module connector or control scheduler of UNILOG GPRS |
| Reset protection | | | C.93.14 | Prevents reset of status register 1 through menu item 8 (<i>Status</i>). If this protection is activated, status register 1 can only be reset after opening and closing the housing of UNIGAS 300. As standard this function is deactivated |
| Setting | | | 0.8.5 | logger interval for release of P01 in 5, 10, 15, 30 or 60 min |

Protection level 1: password 2b

| Name | Unit | OBIS code | Description |
|----------------|------|-----------|--|
| Alarm output 1 | | C.93.4 | Selector switch for relaying a status bit to alarm output 1. If the status is active and persistent, an impulse will be sent to the output every 5-min interval at the moment when it arises |
| Alarm output 2 | | C.93.5 | Selector switch for relaying a status bit to alarm output 2. If the status is active and persistent, an impulse will be sent to the output every 5-min interval at the moment when it arises |

Status register 1; calibration-relevant alarms

OBIS code: 97:97:1. See chapter 6 for more information on the definition of the status bits.

Status register 2; operational status

OBIS code: 97:97:2. See chapter 6 for more information on the definition of the status bits.

Status register 3; other alarms and warnings

OBIS code: 97:97:3. See chapter 6 for more information on the definition of the status bits.

Status register 4; VDEW status register

OBIS code: 97:97:4. The VDEW status register is used to mark the status of an interval logging, day logging and month logging for the validation of logged data. The following status bits are based on the combination of status registers 1, 2 and 3 and are in accordance with the harmonised arrangements on status marking according to VDEW.

| Status bit number | Description |
|-------------------|---|
| 15 / F | No function |
| 14 / E | Loggers erased |
| 13 / D | One or both log books erased |
| 12 / C | No function |
| 11 / B | No function |
| 10 / A | Conversion error ended |
| 9 | Conversion error: error in p or T |
| 8 | Calibration setting modified |
| 7 | External power supply failed |
| 6 | UNIGAS 300 has been without voltage |
| 5 | Clock has been moved more than ns, see chapter 10, <i>Other settings for functions of UNIGAS 300</i> |
| 4 | A counter has been reset to 0 |
| 3 | Summer time active |
| 2 | No function |
| 1 | Active alarm: Alarm input 1, Alarm input 2, NAMUR short-circuit, NAMUR interruption |
| 15 / F | Fatal error: empty battery, watchdog conversion, CRC error conversion, watchdog interface or CRC error in top PCB interface |

11 Technical specifications

General

| | |
|--|--|
| Dimensions | 194 x 120 x 70 mm |
| Material | Coated aluminium, suitable for installation in direct sunlight |
| Weight | Approx. 1.5 kg |
| Cable glands | 2 x Ø 2 – 5 mm 5 x Ø 5 – 9 mm |
| Module space | Yes |
| Space for additional power supply module | Yes |
| Fraud detection | On opening housing |
| Ambient conditions | - -40 – +55 °C - 0 – 100% relative humidity, condensing |
| Protection class | IP66 (jet proof) |
| Medium conditions | - -40 – +55 °C - 0.8 – 20 bar (abs) |
| Mechanical class | M2 in accordance with EN 12405-1/A1 |
| Electrical class | E2 in accordance with EN 12405-1/A1 |



Metrology

| | |
|---|--|
| Approval | - MID 002, MID 2004/22/EC by NMi - NMi T10132 |
| Measuring interval for pressure and temperature | 5 – 25 s, configurable, standard 25 s |
| Conversion interval | - LF: every impulse - HF: every second (if impulses are present) - encoder: every measuring interval |
| Standard | EN 12405-1/A1 |
| Measuring error on delivery | Lower than 0.4 % of the measured value |

Explosion safety

| | |
|---------------------------|---|
| ATEX | Intrinsically safe in accordance with: - II 1 G, Ex ia IIC T4 (for installation in zone 0) - II (1) G [Ex ia] IIC (for installation in safe zone) |
| Approval | 08ATEX0015 X |
| Serial outputs | Optically galvanically separated; Ex earthing not required |
| Impulse and alarm outputs | Optically galvanically separated; Ex earthing not required - in zone 0: $U_i = 20\text{ V}$, $I_i = 600\text{ mA}$, $P_i = 480\text{ mW}$, $C_i = 27\text{ nF}$, $L_i = 0\text{ mH}$ - safe zone: $U_n = 20\text{ VDC}$, $U_m = 250\text{ V}$; outputs can directly be connected to third-party equipment |
| External power supply | $U_i = 10\text{ V}$, $I_i = 600\text{ mA}$, $C_i = 1,7\text{ }\mu\text{F}$, $L_i = 0\text{ mH}$ |

Electrical power supply

| | |
|--|--|
| External power supply | Voltage: 5 – 10 V DC Power consumption: $\leq 55\text{ mA}$ (depending on use of LF, encoder or HF) 100 mA peak (max 1 ms) |
| Internal battery power | D cell or DD cell Lithium-Thionyl chloride Nominal voltage: 3.6 V  The DD cell shall be used for applications at ambient temperatures up to below $-20\text{ }^\circ\text{C}$ and applications of encoder counters  When using a measuring interval of less than 10 s, external power supply must be used. |
| Service life D cell In normal use, impulse outputs activated communication with data collection system once a day and 15-min display use per month | PTZ version - typically 10 years without use of encoder input - typically 8 years with use of encoder input (5-min measuring interval) TZ version - typically 12 years without use of encoder input - typically 10 years with use of encoder input (5-min measuring interval) |
| Service life DD cell In normal use, impulse outputs activated communication with data collection system once a day and 15-min display use per month | PTZ version - typically 15 years without use of encoder input - typically 5 years with use of encoder input (25-s measuring interval) - typically 13 years with use of encoder input (5-min measuring interval) TZ version - typically 15 years without use of encoder input - typically 6 years with use of encoder input (25-s measuring interval) - typically 13 years with use of encoder input (5-min measuring interval) |

| | |
|--|--|
| Battery condition | - indicator in main screen - remaining capacity in menu |
| Capacity of D cell | 18.5 Ah |
| Capacity of DD cell | 35 Ah |
| Life of D cell as a backup at HF-inlet and external supply | 1,000 hours |

Human interface

| | |
|--|--|
| Display | Graphic LCD, 66 x 33 mm, 8 lines with 20 characters |
| Readability of display | ≥ -25 °C |
| Resolution of counters | XXXXXXXX.XXX m ³ (8 numerals and 3 decimals) |
| Resolution of pressure and temperature | XXXX.XX mbar respectively °C (4 numerals and 2 decimals) |
| Navigation keys | 4 |
| Data display | - 2 screen displays with current measuring data and counters - other information through menu |
| Configurable through navigation keys | Adjustment of pressure sensor and temperature sensor (protected by the calibration switch) |

Signal inputs

| | |
|--------------------------------|---|
| Number of inputs | 6 |
| Connection | Screw terminals |
| NAMUR input | HF or encoder input (for conversion), configurable to counter 1 or 2 |
| Impulse input 1 | LF input (for conversion), configurable to counter 1 or 2 |
| Impulse input 2 | LF input for counter 2 |
| Impulse input 3 | LF input for counter 3 |
| Alarm input 1 | Input for normally closed contact |
| Alarm input 2 | Input for normally closed contact |
| Specification of LF inputs | 3.6 V, 6 µA, reed or transistor |
| Maximum frequency | 2 Hz |
| Minimum impulse duration | 75 ms |
| Scaling factor | Counter 1: 1 – 100,000 imp/m ³ configurable Counters 2 and 3: 1 – 100 imp/m ³ configurable |
| Specification of HF | NAMUR, 5 kHz DC 50%, mains power necessary (1000 h emergency power supply from D cell in case of power failure) |
| Maximum frequency | 5 kHz |
| Minimum impulse duration | 100 µs |
| Error curve correction | Linear interpolation on the basis of a maximum of ten coordinates of the measuring error curve of the gas meter |
| Specifications of encoder | NAMUR, suitable for encoder counters of GWF and Elster |
| Specifications of alarm inputs | 3.6 V, 6 µA, reed or transistor |

Pressure sensor

| | |
|--------------------------------|--|
| Type | PDCR series |
| Measuring principle | Silicon piezo-resistive |
| Dimensions | Ø 25 x 82 mm |
| Connection | G¼, flat seal |
| Classification pressure ranges | - 0.8 – 2.5 bar (abs.) - 1.5 – 6 bar (abs.) - 2.5 – 10 bar (abs.) - 5 – 20 bar (abs.) |
| Standard | EN 12405-1/A1 |
| Maximum overload | Twice maximum pressure without loss of accuracy |
| Adjusting | Offset adjustable on display and keys after breaking seal and operating programming switch |
| Version | - internal - external, with approx. 3 m of cable |

Temperature sensor

| | |
|--------------------------|---|
| Type | Pt500, twin-core |
| Dimensions | Approx. Ø 5.8 x 45 mm |
| Temperature range medium | -40 – +55 °C |
| Standard | EN 12405-1/A1 |
| Adjusting | Offset at 0 °C and span in positive and negative temperature range adjustable through display and keys after breaking the seal and operating the programming switch |
| Version | External, with approx. 3 m of silicone cable |

Conversion algorithms

| | |
|-----------------------|---|
| Versions | - PTZ (pressure, temperature and compressibility) - PT (pressure and temperature) - TZ (temperature and compressibility) - T (temperature) |
| Conversion algorithms | - AGA NX19 modified (Gasunie) - SGERG TM5 1991 method 1-4 - AGA 8 gross method 1 |
| Population | Complete algorithm implemented in UNIGAS 300 |

Data storage

| | |
|---|---|
| Loggers: | |
| interval logger (5-min interval) | (150 days, 43200 5-min recordings) V_{b1} , V_{b1err} , V_{m1} , V_{c1} , V_{m2} , V_{m3} , t , p , status message with date/time |
| day logger (end) | (100 days) V_{b1} , V_{b1err} , V_{m1} , V_{c1} , V_{m2} , V_{m3} , t , p , status message with the date/time Storage at 6:00 hours (configurable) |
| month logger (end) | (60 months) V_{b1} , V_{b1err} , V_{m1} , V_{c1} , V_{m2} , V_{m3} , t , p , status message with the date/time Storage at 6:00 hours (configurable) |
| Log books: | |
| status log book storage of status messages | (360 lines) recording of status messages with date/time |
| calibration log book storage of changes of calibration parameters | (360 lines) recording of modification of counter readings and calibration-relevant parameters through the recording of old and new parameter values, V_{b1} and V_{c1} and status messages with date/time |

Signal outputs

| | |
|--|---|
| Number of outputs | 4, configurable |
| Impulse outputs 1 and 2 | - V_{b1} or - $V_{b1,err}$ or - V_{m1} or - V_{c1} or - V_{m2} or - V_{m3} |
| Maximum frequency | 2 Hz |
| Scaling factors | 1 – 100 m ³ /impulse, configurable |
| Impulse width | 100 - 150 ms (depending on switching voltage presented and current to be switched) |
| Alarm outputs 1 and 2 | Alarm output, configurable |
| Activation | Activation on reaching preset status message |
| Impulse width | 100 - 150 ms, repeat impulse every 5-min interval on active alarm |
| Connection | Screw terminals |
| Specification of switching voltage and current | Suitable for switching voltage of 3 – 20 V and switching current of 6 – 50 mA. |

Communication ports

| | |
|---|---|
| Communication port 1 (for modem) | <ul style="list-style-type: none"> - serial, screw coupling - infrared connector - sealable with a sticker seal |
| Communication port 2 | <ul style="list-style-type: none"> - serial, magnetic coupling - infrared communication head in accordance with IEC 62056-21 |
| Communication port 3 (for local serial communication) | <ul style="list-style-type: none"> - serial, screw coupling - infrared connector - sealable with a sticker seal |
| Specifications | <ul style="list-style-type: none"> - 9600 Baud, 7E1 - objects in accordance with OBIS (EN 13757-1), VDEW - IEC 62056-21 (formerly IEC 61107) - reading of current and stored data - reading and writing of calibration data (calibration lock) - reading and writing of supplier data (supplier lock) - reading and writing of client data (client lock) |

Status messages

| | |
|---|---|
| Exceeding of alarm Q_{b1} | Flow rate converted volume, configurable between 1 and 10,000 m ³ /h |
| Exceeding of warning Q_{b1} | Flow rate converted volume, configurable between 1 and 10,000 m ³ /h |
| Exceeding of alarm V_{b1-60} | Converted consumption in clock hour, configurable between 1 and 10,000 m ³ |
| Exceeding of warning V_{b1-60} | Converted consumption in clock hour, configurable between 1 and 10,000 m ³ |
| Exceeding of alarm Q_{c1} | Flow rate corrected unconverted volume, configurable between 1 and 10,000 m ³ /h |
| Exceeding of warning Q_{c1} | Flow rate-corrected unconverted volume, configurable between 1 and 10,000 m ³ /h |
| Exceeding of alarm V_{c1-60} | Corrected unconverted consumption in clock hour, configurable between 1 and 10,000 m ³ |
| Exceeding of warning V_{c1-60} | Corrected unconverted consumption in clock hour, configurable between 1 and 10,000 m ³ |
| Exceeding e of volume difference between counters 1 and 2 | Configurable between 1 and 100 m ³ |
| Exceeding of alarm p_{max} | Configurable between 800 and 100,000 mbar |
| Exceeding of alarm p_{min} | Configurable between 800 and 100,000 mbar |
| Exceeding of alarm t_{max} | Configurable between -50 and 100 °C |
| Exceeding of alarm t_{min} | Configurable between -50 and 100 °C |
| Alarm input 1 | Open contact recorded on alarm input 1 |
| Alarm input 2 | Open contact recorded on alarm input 2 |
| Status messages regarding: | <ul style="list-style-type: none"> - metrology - inputs and outputs - clock - opening of housing - calibration lock - log books - volume difference - electrical power supply |

Clock

| | |
|----------------------------|-------------------------------|
| Type | POSIX |
| Summer / winter time (DST) | In accordance with 2000/84/EC |
| Typical accuracy | 20 ppm at 25 °C |

Compatibility

| | |
|----------|---|
| Hardware | <ul style="list-style-type: none"> - UNILOG MU - UNILOG GPRS - ISC 230 |
| Software | UNITOOL, suitable for operating systems Windows 2000, Windows XP, Windows Vista and Windows 7 |

Standards /directives

| | |
|--|---|
| Overall | <ul style="list-style-type: none"> - CE mark - RoHS - WEEE |
| Gas volume converter, pressure sensor temperature sensor | <ul style="list-style-type: none"> - EN 12405-1/A1, Gas meters – Conversion instruments – Part 1 Conversion of volume, 2005 - Directive 2004/22/EC on measuring instruments, MI-002, 2004 |
| Software metrology | Welmec 7.2 Software guide (Measuring Instruments Directive 2004/22/EC), 2005 |
| Housing | IEC 60529, Degrees of Protection Provided by Enclosures (IP code) 2001 |
| Explosion hazard | <ul style="list-style-type: none"> - EN-IEC 60079-0, Explosive atmospheres – Part 0: General requirements, 2007 - EN-IEC 60079-11, Explosive atmospheres – Part 11: Equipment Protection by Intrinsic Safety, 2007 - EN-IEC 60079-28, Explosive atmospheres – Part 28: Protection of Equipment and Transmission Systems using Optical Radiation 2006 - EN-IEC 60079-26, Explosive atmospheres – Part 26: Equipment with Equipment Protection Level (EPL) GA, 2007 - 94/9/EC: on the approximation of the laws of the Member States concerning equipment and protective systems intended for use in potentially explosive atmospheres, 1994 |
| Serial communication | <ul style="list-style-type: none"> - EN-IEC 62056-21, Electricity metering - Data exchange for meter reading, tariff and load control - Part 21: Direct local data exchange, 2002 - VDEW Lastenheft, Elektronische Lastgangzähler, Erweiterte Version 2.1.2, 2003 - EN 13757-1 Communicatiesysteem voor meters en het op afstand lezen van meters – Deel 1: Gegevensuitwisseling, 2003 [Communication system for metres and remote reading of meters Part 1: Data exchange, 2003] |

12 EC Declaration of conformity ATEX



EG-verklaring van overeenstemming volgens EC richtlijn 94/9/EC (ATEX) **Kamstrup**

EC-Declaration of Conformity under the EC Directive 94/9/EC (ATEX)
EG-Konformitätserklärung nach EG-Richtlinie 94/9/EG (ATEX)

Fabrikant : **Kamstrup b.v.**
(Manufacturer / Hersteller)

Adres : **Leigraafseweg 4**
(Address / Adresse) **6983 BP DOESBURG**

Land : **Nederland**
(Country / Land) (The Netherlands / Niederlande)

Verklaart dat het hieronder beschreven product voldoet aan onderstaande normen, richtlijnen en gerelateerde documenten:

(Declares that beneath mentioned product is in accordance with the following standards, directives and related documents / Erklärt, dass das untern genannte Produkt mit den folgenden Normen, Richtlinien und dazu gehörige Dokumenten übereinstimmt)

EC Directive 94/9/EC (ATEX) – equipment intended for use in Potentially Explosive Atmospheres
EN 60079-0 : 2006
EN 60079-11 : 2007
EN 60079-26 : 2007
EN 60079-28: 2007

Some standards indicated above are no longer harmonised. A review against the standards listed below, which are harmonised, identified no significant changes relevant to this product. The previously applied standards continue to represent the 'state of the art'.

EN 60079-0 : 2009 (IEC 60079-0:2007)

Deze verklaring is gebaseerd op testrapport:
(This declaration is based upon test report / Dieser Erklärung liegt zugrunde der Prüfbericht)

Test report number 210845200. Issued by KEMA Quality B.V. (notified body number 0344)
Utrechtseweg 310, 6812 AR Arnhem, The Netherlands.

Productnaam : **UNIGAS 300**
(Product name / Produktname)

Productomschrijving : **elektronisch volumeheraldingsinstrument**
(Description / Beschreibung) (electronic volume conversion device / elektronische Zustandsmengenumwerter)

Producttype : **UNIGAS 300 model PTZ, model TZ, model PT en model T**
(Product type / Produkt Typ)

EG-typecertificaat : **KEMA 08ATEX0015 X**
(EC-type examination certificate / EG-Baumusterprüfzertifikat)

Datum : **17-01-2011**
(Date / Datum)

Sjaak Langeveld
Manager R&D

3061 Rev.: 3 Kamstrup b.v., 6983 BP Doesburg, The Netherlands

13 EC Type Examination Certificate



(1) EC-TYPE EXAMINATION CERTIFICATE

- (2) Equipment and protective systems intended for use in potentially explosive atmospheres - Directive 94/9/EC
- (3) EC-Type Examination Certificate Number: **KEMA 08ATEX0015 X** Issue Number: 1
- (4) Equipment: **Gas Volume Corrector Unigas 300 Model PTZ, Model TZ, Model PT and Model T**
- (5) Manufacturer: **Kamstrup b.v.**
- (6) Address: **Leigraafseweg 4, 6983 BP Doesburg, The Netherlands**
- (7) This equipment and any acceptable variation thereto is specified in the schedule to this certificate and the documents therein referred to.
- (8) KEMA Quality B.V., notified body number 0344 in accordance with Article 9 of the Council Directive 94/9/EC of 23 March 1994, certifies that this equipment has been found to comply with the Essential Health and Safety Requirements relating to the design and construction of equipment and protective systems intended for use in potentially explosive atmospheres given in Annex II to the directive.
- The examination and test results are recorded in confidential test report number 210845200.
- (9) Compliance with the Essential Health and Safety Requirements has been assured by compliance with:
- | | |
|---------------------------|---------------------------|
| EN 60079-0 : 2006 | EN 60079-11 : 2007 |
| EN 60079-26 : 2007 | EN 60079-28 : 2007 |
- (10) If the sign "X" is placed after the certificate number, it indicates that the equipment is subject to special conditions for safe use specified in the schedule to this certificate.
- (11) This EC-Type Examination Certificate relates only to the design, examination and tests of the specified equipment according to the Directive 94/9/EC. Further requirements of the directive apply to the manufacturing process and supply of this equipment. These are not covered by this certificate.
- (12) The marking of the equipment shall include the following:



**II 1 G Ex ia IIC T4 or
II (1) G [Ex ia] IIC**

This certificate is issued on April 17, 2008 and, as far as applicable, shall be revised before the date of cessation of presumption of conformity of (one of) the standards mentioned above as communicated in the Official Journal of the European Union.

KEMA Quality B.V.

 C.G. van Es
 Certification Manager

Page 1/3
 PRODIGES
 BNA/C 001

^o Integral publication of this certificate and adjoining reports is allowed. This Certificate may only be reproduced in its entirety and without any change.

KEMA Quality B.V. Utrechtseweg 310, 6812 AR Arnhem P.O. Box 5185, 6802 ED Arnhem The Netherlands
 T +31 26 3 56 20 00 F +31 26 3 52 58 00 customer@kema.com www.kema.com Registered Arnhem 09085396

Experience you can trust.

(13) **SCHEDULE**(14) **to EC-Type Examination Certificate KEMA 08ATEX0015 X** Issue No. 1(15) **Description**

The Gas Volume Corrector Unigas 300 Model PTZ, Model TZ and Model PT and Model T is used for accurate gas volume measurement. The measurement signal from a gas flow meter, connected to the apparatus is corrected for gas temperature and gas pressure (optional).

Correctors Model PTZ and Model PT are equipped with an integrally mounted Pt500 temperature sensor and a certified integrally or externally mounted pressure transducer.

Correctors Model TZ and Model T are equipped with an integrally mounted Pt500 temperature sensor.

The unit is provided with a display and keys for control. The output is a pulse signal and the unit is provided with data communication via 3 infrared interfaces.

The Gas Volume Corrector is supplied by an internal non-rechargeable lithium battery and optionally by an external supply unit.

Ambient temperature range -40 °C to +55 °C.

Electrical data

Power supply (Connector 4 pins 11 and 12):

in type of protection intrinsic safety Ex ia IIC, only for connection to a certified intrinsically safe circuit, with the following maximum values:

$U_i = 10 \text{ V}$; $I_i = 600 \text{ mA}$; $P_i = \text{any}$; $C_i = 1,7 \mu\text{F}$; $L_i = 0 \text{ mH}$.

Power supply (Connector 3 pins 1 and 3):

one Li-SOCL₂ Battery cell, type Saft LS33600C or type Tadiran TL-5937, nominal voltage 3,6 V.

Input circuit LF1, LF2, LF3 (Connector 4 pins 4, 5, 6 and 3, 7):

in type of protection intrinsic safety Ex ia IIC, with the following maximum values, circuits combined: $U_o = 5,0 \text{ V}$; $I_o = 32 \text{ mA}$; $P_o = 40 \text{ mW}$; $C_o = 1 \mu\text{F}$; $L_o = 30 \text{ mH}$.

Input circuit Alarm1, Alarm2 (Connector 4 pins 8 and 10 and 9):

in type of protection intrinsic safety Ex ia IIC, with the following maximum values, per circuit: $U_o = 5,0 \text{ V}$; $I_o = 34 \text{ mA}$; $P_o = 43 \text{ mW}$; $C_o = 1 \mu\text{F}$; $L_o = 30 \text{ mH}$.

Input circuit Namur (Connector 4 pins 1, and 2):

in type of protection intrinsic safety Ex ia IIC, with the following maximum values: $U_o = 9,6 \text{ V}$; $I_o = 37 \text{ mA}$; $P_o = 52 \text{ mW}$; $C_o = 1 \mu\text{F}$; $L_o = 10 \text{ mH}$.

(13) **SCHEDULE**(14) **to EC-Type Examination Certificate KEMA 08ATEX0015 X Issue No. 1**

Output circuit Alarm1, Alarm2, Pulse1, Pulse2 (Connector 11 pins 13, 15, 16, 18 and 14, 17):
in type of protection intrinsic safety Ex ia IIC, only for connection to certified intrinsically safe
circuits, with the following maximum values, per circuit:
 $U_i = 20 \text{ V}$; $I_i = 600 \text{ mA}$; $P_i = 480 \text{ mW}$; $C_i = 27 \text{ nF}$; $L_i = 0 \text{ mH}$.

The input circuits are used for connection to passive circuits.

Three optical interfaces (IRDA):
Inherently safe; optical power < 35 mW.

If the Corrector is installed outside the hazardous area, the following electrical data apply for
Output circuit Alarm1, Alarm2, Pulse1, Pulse2 (Connector 11 pins 13, 15, 16, 18 and 14,17):
 $U_n = 20 \text{ Vdc}$, $U_m = 250 \text{ Vac}$.

All other electrical parameters apply unchanged.

Installation instructions

The battery may be replaced inside the hazardous area, using battery type Saft LS33600C or
type Tadiran TL-5937 only.

For the supply, the internal battery and a suitable certified supply unit may be used simultaneously.

(16) **Test Report**

KEMA No. 210845200.

(17) **Special conditions for safe use**

1. Because the enclosure of the Gas Volume Corrector Unigas 300 is made of aluminium alloy,
when used in a potentially explosive atmosphere requiring apparatus of equipment category
1 G, the Corrector must be installed so, that even in the event of rare incidents, ignition
sources due to impact and friction sparks are excluded.
2. On application of the Corrector in an explosive gas atmosphere requiring the use of apparatus
of equipment category 1 G, precaution shall be taken to avoid danger of ignition due to
electrostatic charges on the enclosure.
3. When used with an external pressure transducer (Model PTZ and Model PT), it must be taken
into account, that from a safety point of view, the circuit of the pressure transducer is
connected to earth.

(18) **Essential Health and Safety Requirements**

Covered by the standards listed at (9).

The compliance with the Essential Health and Safety Requirements of the intrinsically safe
pressure transducers type PDCR IS-0068 and type PDCR IS-0069 has been assured by
compliance with EN 50014 : 1997 + A1, A2, EN 50020 : 1994 and EN 500284 : 1999.

(19) **Test documentation**

As listed in Test Report No. 210845200.

14 EC Declaration of conformity MID

**Kamstrup**

EG-verklaring van overeenstemming volgens EC richtlijn 2004/22/EC (Measuring instruments)

EC-Declaration of Conformity under the EC Directive 2004/22/EC (Measuring instruments)

EG-Konformitätserklärung nach EG-Richtlinie 2004/22/EG (Messgeräte)

Declaración CE de conformidad según la Directiva CE 2004/22/CE (Instrumentos de medida)

Fabrikant : **Kamstrup b.v.**
(Manufacturer / Hersteller / Fabricante)

Adres : **Leigraafseweg 4**
(Address / Adresse / Dirección) **6983 BP DOESBURG**

Land : **Nederland**
(Country / Land / País) (The Netherlands / Niederlande / Países Bajos)

Verklaart dat het hieronder beschreven product voldoet aan onderstaande normen, richtlijnen en gerelateerde documenten:

(Declares that beneath mentioned product is in accordance with the following standards, directives and related documents / Erklärt, dass das unten genannte Produkt mit den folgenden Normen, Richtlinien und dazu gehörige Dokumenten übereinstimmt /

Declara que el producto mencionado a continuación es de conformidad con las siguientes normas, directivas y documentos relacionados)

EC Directive 2004/22/EC (Measuring instruments)
EN 12405-1:2005/A1:2006

Productnaam : **UNIGAS 300**
(Product name / Produktname / Nombre del producto)

Productomschrijving : **elektronisch volumeherleidingsinstrument**
(Description / Beschreibung / Descripción) (electronic volume conversion device / elektronische Zustandsmengenumwerter / conversor electrónico de volumen)

Producttype : **UNIGAS 300**
(Product type / Produkt Typ / Tipo de producto)

Klasse : **M2, E2**
(Class / Klasse / Class)

EG-typcertificaat : **T10132**
(EC-type examination certificate / EG-Baumusterprüfzertifikat / Certificado de examen CE de Tipo) Issued by NMI Certin B.V. (Notified Body number 0122) Hugo de Grootplein 1, 3314 EG Dordrecht, The Netherlands

Datum : **17-01-2011**
(Date / Datum Fecha)

Sjaak Langeveld
Manager R&D

15 MID EC Type Examination Certificate



EC type-examination Certificate

Number **T10132** revision 4
 Project number 11200370
 Page 1 of 1

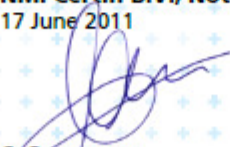
| | | |
|--|---|--|
| Issued by | NMI Certin B.V., designated and notified by the Netherlands to perform tasks with respect to conformity modules mentioned in article 9 of Directive 2004/22/EC, after having established that the Measuring instrument meets the applicable requirements of Directive 2004/22/EC, to: | |
| Manufacturer | Kamstrup B.V. Leigraafseweg 4 6983 BP Doesburg The Netherlands | |
| Measuring instrument | An electronic gas-volume conversion device (EVCD) , intended to be used for gas volume conversion as a sub-assembly (according to article 4 of the MID) of a gas meter. Type : UNIGAS 300 Conversion principle : T, TZ, PT or PTZ Device type : 1 (complete system) Ambient temperature range : -40 °C / +55 °C Designed for : condensing humidity Environment classes : M2 / E2 The intended location for the instrument is open. Further properties are described in the annexes - Description T10132 revision 4 - Documentation folder T10132-1 | |
| Valid until | 11 November 2018 | |
| Remarks | This revision replaces the earlier versions, except for its documentation folder. This revision is issued due to the addition of new software. | |
| Issuing Authority | NMI Certin B.V., Notified Body number 0122 17 June 2011  C. Oosterman Head Certification Board | |
| NMI Certin B.V. Hugo de Grootplein 1 3314 EG Dordrecht The Netherlands T +31 78 6332332 certin@nmi.nl www.nmi.nl | This document is issued under the provision that no liability is accepted and that the applicant shall indemnify third-party liability. The designation of NMI Certin B.V. as Notified Body can be verified at http://ec.europa.eu/enterprise/newapproach/hando/ | Parties concerned can lodge objection against this decision, within six weeks after the date of submission, to the general manager of NMI (see www.nmi.nl). Reproduction of the complete document only is permitted. |



16 Correction of gas meter measuring error

When the gas meter has been calibrated and the calibration data of the gas meter measurement error are known, then, according to EN12405-1 (clause 4.4) the gas meter readings may be corrected by an electronic gas volume converter on the basis of a number of checkpoints at which the meter measuring error has been determined. The number of checkpoints may vary per gas meter.

A maximum of ten checkpoints can be programmed in UNIGAS 300 for correction of the gas meter measuring error.

The UNITOOL software can be used to configure the gas meter checkpoints in UNIGAS 300 with the connected correction values.

On the basis of linear interpolation and the current flow rate, UNIGAS 300 carries out the correction according to the following formula:

$$Vc1 = Vm1 \times Cf$$

As the gas meter measuring error at the checkpoints is expressed in %, this error must be converted into the connected Cf value for each point.

$$Cf = \frac{100}{\text{measuring error} + 100}$$

Where:

Measuring error = listed gas meter measuring error expressed in %

Example: a measuring error of + 2 % will result in Cf = 0.9804

UNIGAS 300 carries out the measuring error correction under the following conditions:

- correction will only take place at an impulse frequency of more than ten impulses/s and/or a flow rate $Q \geq Q_{\min}$ the gas meter. Otherwise Cf=1
- correction takes place on the basis of linear interpolation between Q_{\min} and Q_{\max} of the gas meter
- if $Q > Q_{\max}$ of the gas meter, then Cf = Cf for Q_{\max}

The checkpoints are programmed sequentially in UNIGAS 300 while:

- the first point Q1 – C1 always matches the measuring error at Q_{\min} of the gas meter
- the last point Qn – Cn always matches the measuring error determined at Q_{\max} of the gas meter
- the intermediate checkpoints are in the order of increasing Q
- if less than ten checkpoints are available, the remaining checkpoints are programmed with Q = 0



In UNIGAS 300 the sequence is not checked when other checkpoints are entered. This is left to the authority of the verification officer.

UNIGAS 300 does check the range of the values:

Q: 0 – 10,000 m³/h

C: 0.9000 – 1.1000

17 Determination of volume difference when two impulse inputs are used

UNIGAS 300 features an alarm function for the volume difference between counters 1 and 2. This refers to counters connected to inputs 1 and 2 (non-converted values).

For that purpose an additional counter $Vm2'$, which increases simultaneously with counter $Vm2$, is connected to input 2. This counter is not readable and it is only used to determine the volume difference.

Every 5-min interval the volume difference is determined according to the following formula:

$$\text{Volume difference} = |Vm2' - Vm1|$$

If the volume difference exceeds the preset alarm value, UNIGAS 300 will carry out the following actions:

- status register 2.12 (alarm_volume_difference) is activated
- event is recorded in the status log book and in the interval logging of that moment
- $Vm2'$ is set equal to $Vm2$, so the volume difference can again be determined in the next period

The graph of the above function is shown below.

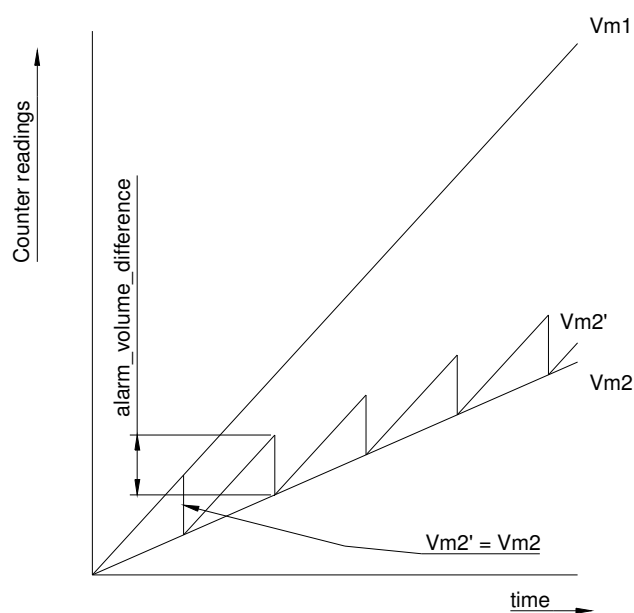

When the interval logger is read out afterwards, the logging statuses show whether a volume difference has occurred. If so, the impulse input of the gas meter or the connection between the gas meter and UNIGAS 300 must be inspected.

The trigger value of the volume difference can be adjusted by means of UNITOOL using register C.92.9 (see chapter 10). If a value "0" is programmed the function is switched off.



Kamstrup b.v.
PO Box 109
NL-6980 AC Doesburg
Leigraafseweg 4
NL-6983 BP Doesburg
TEL: +31 (0) 313 – 47 19 98
FAX: +31 (0) 313 – 47 32 90
kamstrup@kamstrup.nl
www.kamstrup.nl

DDG6005MHGB/4.2011/Rev. 5